

# WEBS-35C3

## Fan-less Embedded System

AS5-3459

AS5-3463



## User's Manual

Version 1.1

Copyright © Portwell, Inc., 2017. All rights reserved.  
All other brand names are registered trademarks of their respective owners.

# Table of Contents

## How to Use This Manual

<b>Chapter 1 System Overview</b> .....	<b>1-1</b>
1.1 Introduction.....	1-1
1.2 Check List.....	1-2
1.3 Product Specification.....	1-2
1.4 Mechanical Dimension.....	1-3
<b>Chapter 2 System Installation</b> .....	<b>2-1</b>
2.1 CPU and Memory module Installation.....	2-1
2.2 HDD Installation.....	2-4
2.3 PCIe/PCI Add-on Card Installation.....	2-5
2.4 I/O Interfaces.....	2-12
2.4.1 Front View.....	2-12
2.4.2 Rear View.....	2-13
2.5 Getting Started.....	2-16
<b>Chapter 3 BIOS Setup Information</b> .....	<b>3-17</b>
3.1 Entering Setup.....	3-17
3.2 Main.....	3-18
3.3 Configuration.....	3-19
3.4 Security.....	3-44
3.5 Boot.....	3-45
3.6 Save & Exit.....	3-46
<b>Chapter 4 Important Instructions</b> .....	<b>4-1</b>
4.1 Note on the Warranty.....	4-1
4.2 Exclusion of Accident Liability Obligation.....	4-1
4.3 Liability Limitations / Exemption from the Warranty Obligation.....	4-1
4.4 Declaration of Conformity.....	4-1
<b>Chapter 5 Frequent Asked Questions</b> .....	<b>5-1</b>

## How to Use This Manual

The manual describes how to configure your WEBS-3583 system to meet various operating requirements. It is divided into four chapters, with each chapter addressing a basic concept and operation of Fan-less Embedded System.

**Chapter 1: System Overview.** Present what you have in the box and give you an overview of the product specifications and basic system architecture for this fan-less embedded system.

**Chapter 2: System Installation.** Show the definitions and locations of all the interfaces and describe a proper installation guide so that you can easily configure your system.

**Chapter 3: BIOS Setup Information.** Specify the meaning of each setup parameters, how to get advanced BIOS performance and update new BIOS. In addition, POST checkpoint list will give users some guidelines of trouble-shooting.

**Chapter 4: Important Instructions.** Indicate some instructions which must be carefully followed when the fan-less embedded system is used.

The content of this manual is subject to change without prior notice. These changes will be incorporated in new editions of the document. The vendor may make supplement or change in the products described in this document at any time.

## Revision History

Revision	Date	Details of Change(s)
V1.0	2017/5/18	Initial Release
V1.1	2021/11/16	Modify 1.3 about I210AT description

# Chapter 1

## System Overview

### 1.1 Introduction

Portwell announces WEBS-35C3, a high performance fan-less Box PC. Powered by the 6th generation Intel Core processor (formerly codenamed Skylake-S) with integrated Intel Gen9 graphics engine, the WEBS-35C3 system supports high-resolution triple-display output, serving as an ideal platform for performance and graphics-demanding applications.

Portwell's WEBS-35C3 is designed to be power-optimized and value-optimized. Instead of adopting a mobile CPU like a traditional embedded system, WEBS-35C3 utilizes a 35W Intel desktop CPU and Intel Q170 chipset, which is more economical compared to its mobile counterpart and provides great efficacy as well as low power consumption; this makes WEBS-35C3 not only competitive but outstanding in the market. The system further takes advantage of the 6th generation Intel Core processor technologies supporting dual-channel DDR4 memory up to 32GB.

Furthermore, the WEBS-35C3 Box PC includes rich I/O interfaces and fast connectivity with three independent display (DisplayPort/HDMI/VGA) interfaces with resolution up to 4K, two Gigabit Ethernet ports, two RS-232/422/485 ports, four RS-232 ports, two USB 2.0 and four USB 3.0 ports, one 8 bits GPIO port, and Mic-in/Line-in/Line-out. Optional wireless, 3G or LTE modules can be added via a Mini PCIe slot or M.2 socket.

In addition, the embedded board that drives the WEBS-35C3 system features an innovative PCI/PCIe expansion module. Users can easily maintain or replace the PCI/PCIe module via a unique gold finger design or extended from 1x PCIex16 slot. Expansion interfaces include 2x PCIe x1, 1x PCI and 1x PCIe x1, and 2x PCIe x8. So There are two system part number for customer to choose suitable solution. They are AS5-3459 with 2x PCIe x1 or 1x PCI + 1x PCIe x1 by assembly to order and AS5-3463 with 2x PCIe x8.

The rugged, fan-less design makes the WEBS-35C3 durable in harsh environment applications, such as factory automation and industrial automation. Portwell's WEBS-35C3 has already passed a vibration test of 5Grms/ 5~500Hz and a shock test of 50G, assuring its solidity and reliability.

In addition, the system accepts a wide input voltage range from 12V to 36V. This power-source flexibility enables product usage in a variety of situations. Moreover, the WEBS-35C3 is more than a robust and dependable embedded system with high performance and graphics efficacy, its stylish mechanical design enhances the system's artistry. Potential applications include kiosk, intelligent digital security, IVI, factory automation and surveillance applications, and many more.

## 1.2 Check List

The WEBS-35C3 package should cover the following basic items:

- ✓ One WEBS-35C3 Fan-less Embedded System
- ✓ One Wall Mount Kit
- ✓ Other Accessories

If any of these items is damaged or missing, please contact your vendor and keep all packing materials for future replacement and maintenance.

## 1.3 Product Specification

System	
M/B	WADE-8017-WS
System Chipset	Intel® Q170 chipset
CPU	Intel® Core™ i7-6700TE Processor. 2.4 GHz. Up to 3.4 GHz. 8M L2 Cache. 35W TDP. (4C/8T) Intel® Core™ i5-6500TE Processor. 2.3 GHz. Up to 3.3 GHz. 4M L2 Cache. 35W TDP. (4C/4T) Intel® Core™ i3-6100TE Processor. 2.7 GHz. 4M L2 Cache. 35W TDP. (2C/4T) Intel® Pentium® G4400TE Processor. 2.9 GHz. 3M L2 Cache. 35W TDP. (2C/2T) Intel® Celeron® G3900TE Processor. 2.3 GHz. 2M L2 Cache. 35W TDP. (2C/2T)
BIOS	AMI uEFI BIOS (SPI ROM)
System Memory	Dual 260-pin UB-DIMM sockets support DDR4 2133/1866 Non-ECC up to 32GB
Storage	2x 2.5" SATA HDD/SSD, 1x mSATA(via mini PCIe socket)
Watchdog Timer	Programmable via S/W from 1 sec. to 255 sec.
H/W Status Monitor	-Temperature (CPU & System) -Speed (CPU Fan & System Fan) -Voltage (CPU Vcore, 12V, 5V, 3.3V, VDIMM)
Expansion	-1x M.2 socket (type E) with PCIe x1, USB 2.0, SDIO, UART, or I2C signal -Expansion slot options: 2x PCIe x16 slot (PCIe x8 signal) 2x PCIe x 4 slot (PCIe x1 signal) 1x PCIe x4 slot (PCIe x 1 signal) + 1x PCI slot
External I/O	
Series Ports	2x RS-232/422/485 selectable by BIOS & 4x RS-232
Display	1x VGA, 1x DP, 1x HDMI
USB	4x USB 3.0, 4x USB 2.0
Audio	Lin-in/Lin-out/Mic-in (ALC886)

LAN	2x Gigabit Ethernet (Intel® I219LM + I210AT)
GPIO	1x Programmable 8-bit digital I/O
Other	-2x Antenna holes for WIFI, 3G/GPS or 4G LTE module -1x EXT Power switch
<b>Power Supply Unit</b>	
Power Supply	DC 12~36V with 3-pin terminal block connector
<b>Environment</b>	
Operating Temperature	-20°C to 50°C with Turbo boost Disabled in BIOS (Default) -20°C to 40°C with Turbo boost Enabled in BIOS
Storage Temperature	-40°C to 80°C
Relative Humidity	95% @ 40°C, non-condensing
Operating Vibration	5Grms/5~500Hz, IEC 60068-2-6
Operating Shock	50G, 11 msec, IEC 60068-2-27
<b>Mechanical</b>	
Dimension (WxDxH)	253 x 201 x 123 mm
Weight	7 kg
Mounting	Wall Mount

## 1.4 Mechanical Dimension

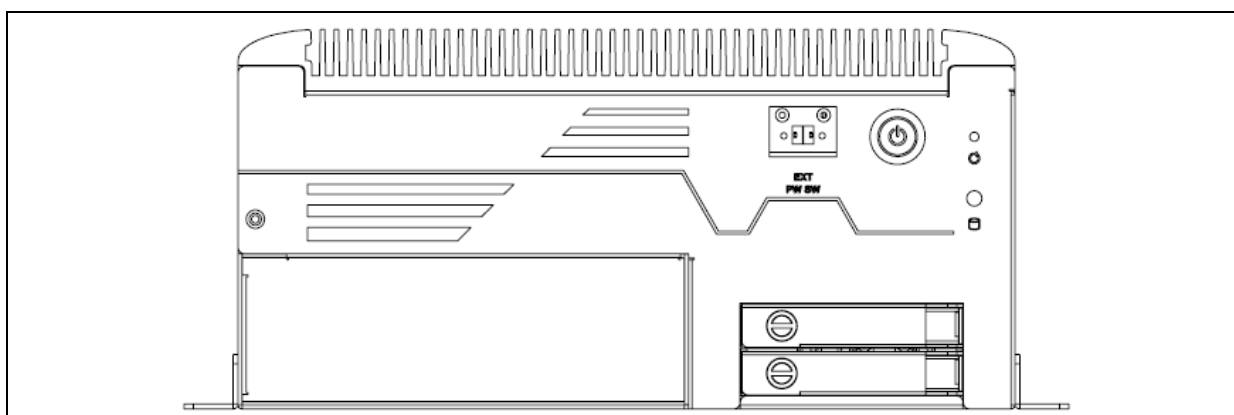

Front view of the WEBS-35C3 system

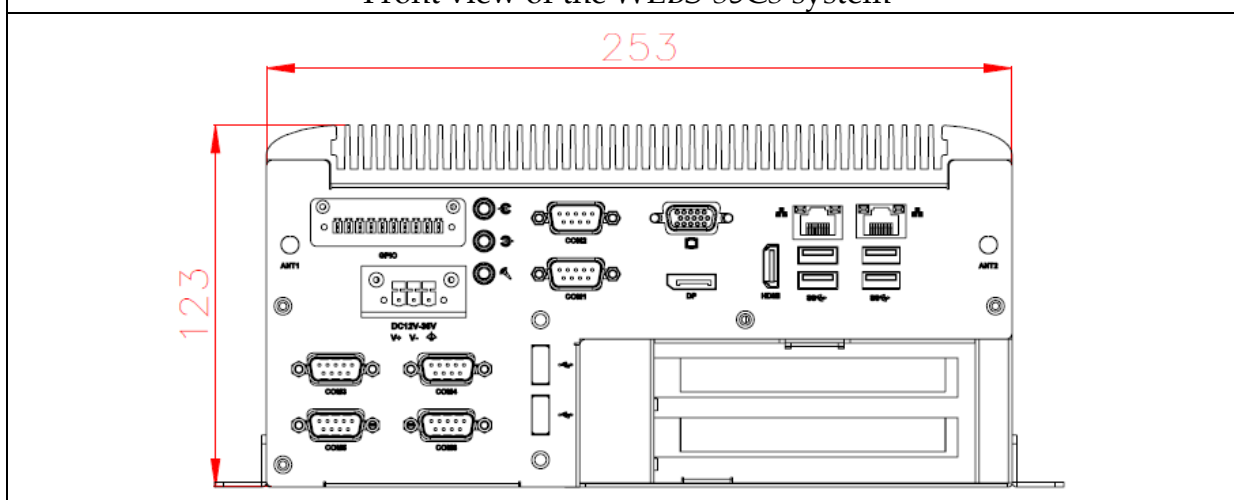

Rear view of the WEBS-35C3 system

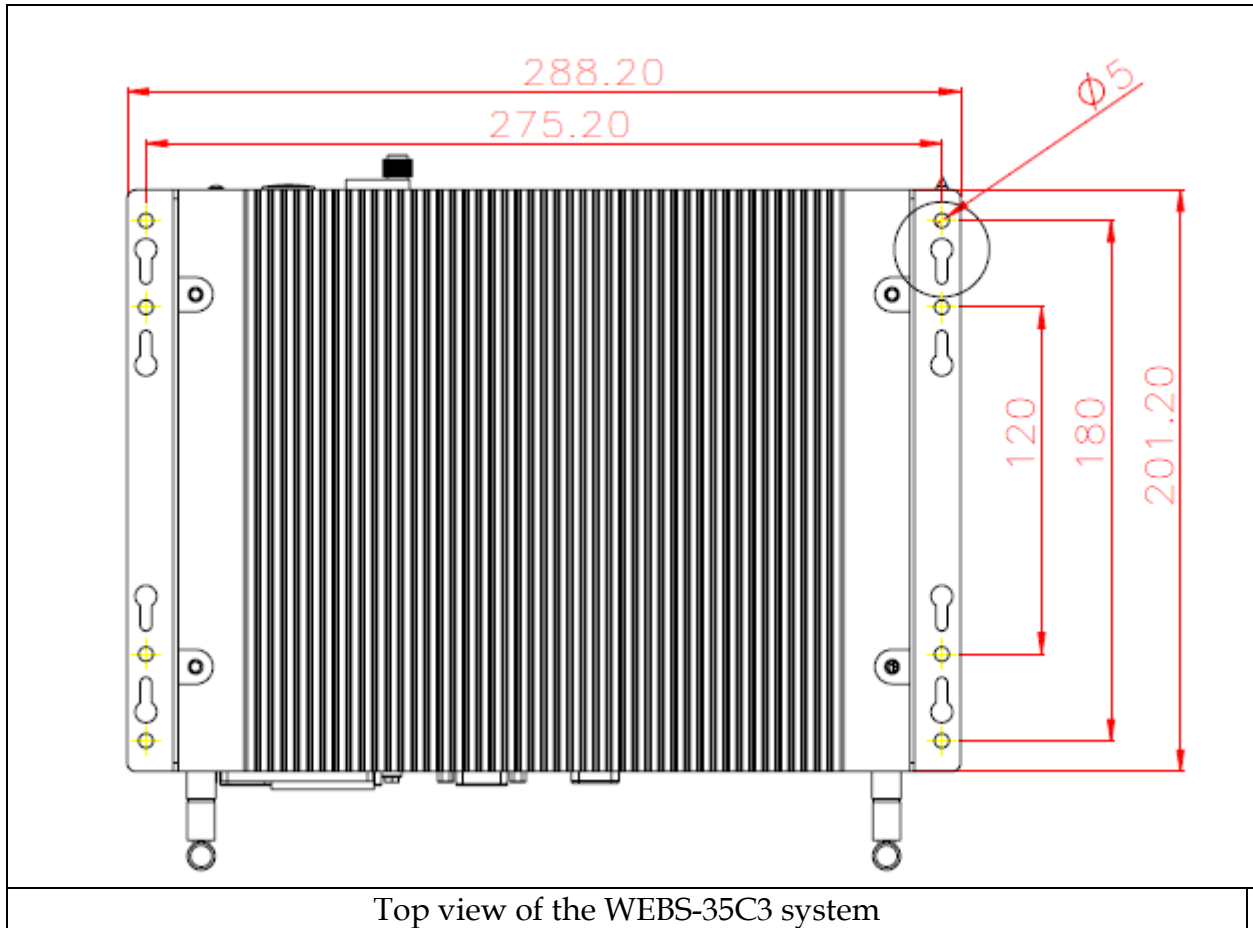





## Chapter 2 System Installation

This chapter provides you with instructions to set up your system. Definitions and locations of all the interfaces are described so that you can easily configure your system. For more detailed PIN assignment and jumper setting, please refer to user's manual of WADE-8017.

### 2.1 CPU and Memory module Installation

Equipped with CPU and Memory module by yourself if you purchase CPU or Memory module locally.

<p>Step 1. Loosen the screws of top heatsink (there are 4 screws)</p>	<p>Step 2. Check system inside</p>
	
<p>Step 3. Open CPU Socket before installing CPU.</p>	<p>Step 4. Remove CPU socket protection cover</p>
	



Step 5. Install CPU. Please locate notches on both side and pin one of CPU first

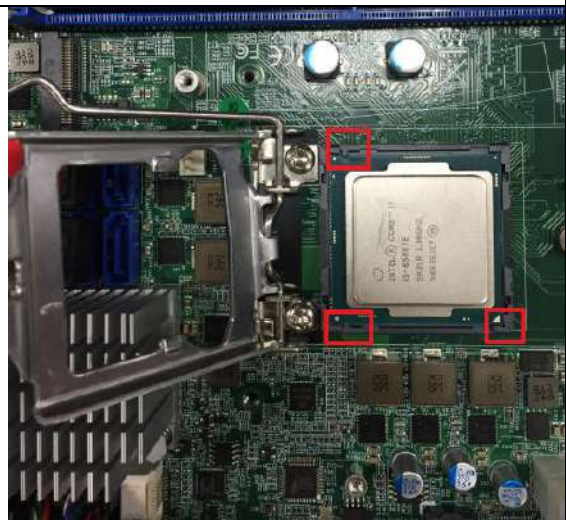

Step 6. Install CPU successfully



Step 7. Remove film of thermal pad on heat spreader

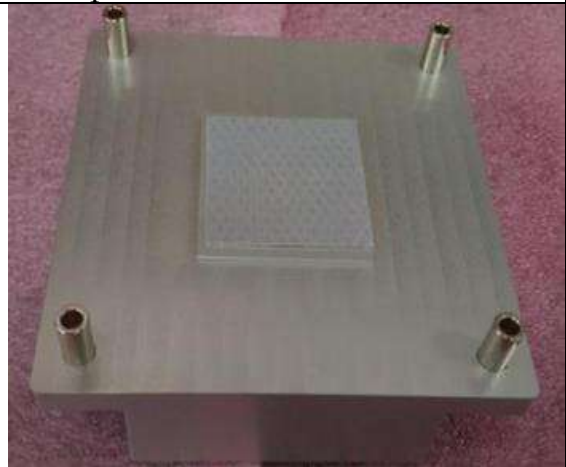

Step 8. Remove film of thermal pad on heat spreader

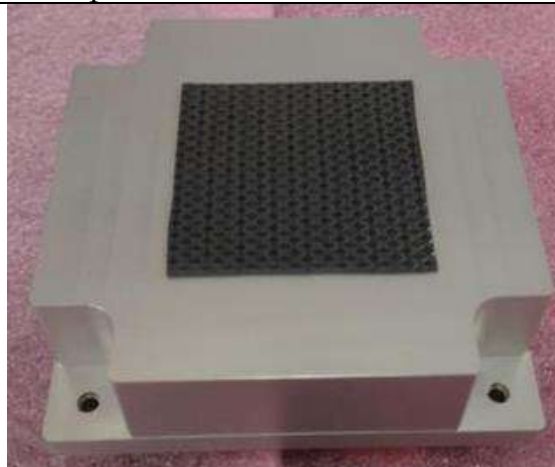

Step 9. Assemble CPU heat spreader

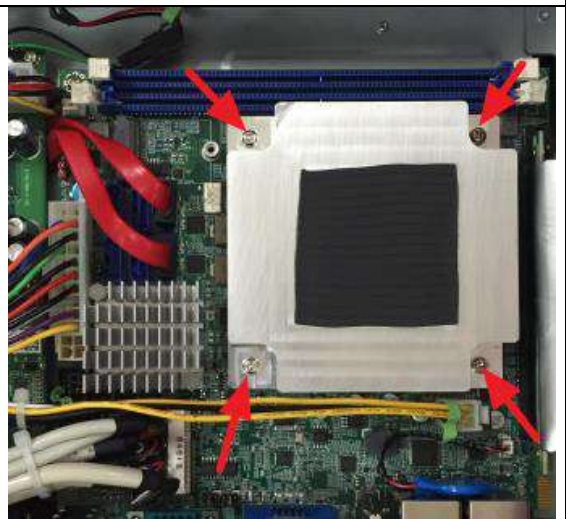

Step 10. Install DDR4 Long DIMM Memory Module on the system



Step11. Make sure CPU and Memory module are installation successfully



Step12. Fixed the screws of top heatsink (there are 4 screws)



## 2.2 HDD Installation

Unique design of the HDD tray allows easy installation and maintenance of 2.5" HDD/SSD. RAID function is supported with dual HDD/SSD design. (The height must be less than 10mm)

Step 1. Loosen the thumbscrews of the HDD cover



Step 2. Draw out the HDD tray from the system



Step 3. Install the HDD into tray with screws



Step 4. Push the HDD tray back and finish installation



## 2.3 PCIe/PCI Add-on Card Installation

Equipped with an innovative PCI/PCIe expansion module, user can easily install and replace their own expansion cards.

Please note there are two part number for WEBS-35C3. AS5-3459 is with 2x PCIe x4 or 1x PCI + 1x PCIe x4 slot by assembly to order and AS5-3463 is with 2x PCIe x16 slots

**There are three types of riser cards:**

- 2x PCIe x4 slots (with PCIe x1 signal)



- 1x PCI slot & 1x PCIe x4 slot (with PCIe x1 signal)  
\*Note: Power cable between main system and the riser card is needed to supply enough power for PCI card.

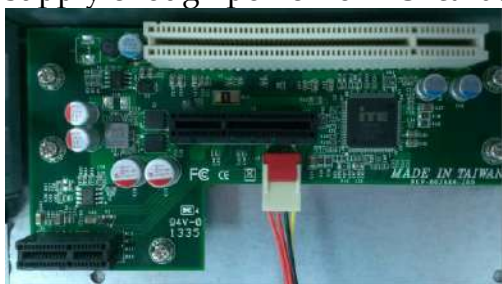

- 2x PCIe x16 slots (with PCIe x8 signal)





Install PCIe/PCI add-on card on 2x PCIe x4 riser card or 1x PCI and 1x PCIe x4 riser card.

Step 1. Loosen the screws of the expansion module

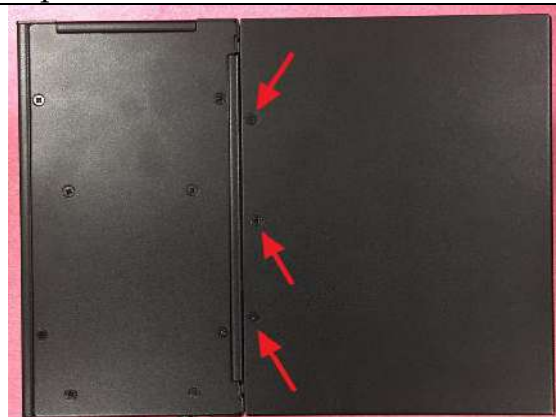

Step 2. Loosen the screws of the expansion module

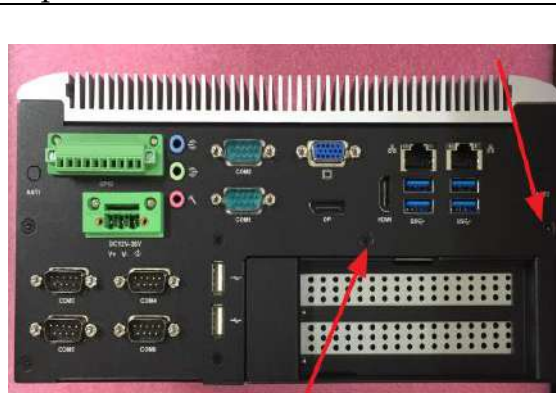

Step 3. Loosen the screws of the expansion module



Step 4. Loosen the screws of the expansion module



Step 5. Take out PCIe expansion module from right hand direction

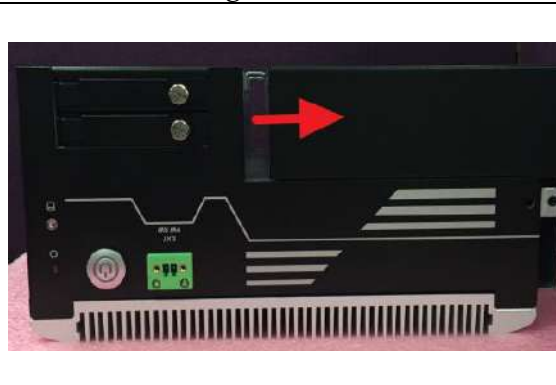

Step 6. See WEBS-35C3 without PCIe expansion module

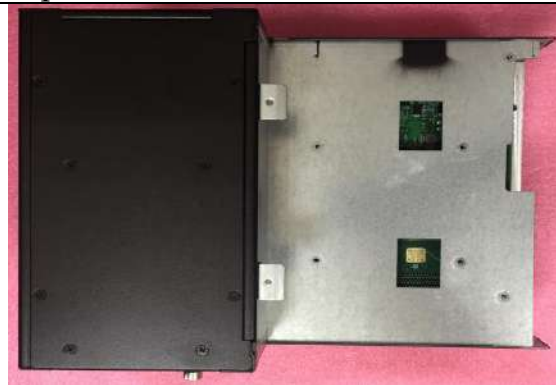

Step 7. Loosen the screws of metal cover on PCIe expansion module



Step 8. Loosen the screws of bracket



Step 10. Prepare USB 3.0 PCIex 1 add-on card for installation



Step 10. Install USB 3.0 PCIex 1 add-on card on riser card.



Step 11. Fix the screws of metal cover on PCIe expansion module



Step 12. Install PCIe expansion module to left hand direction

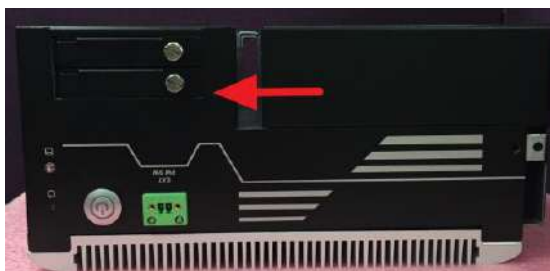

Step 13. Fix the screws of the expansion module

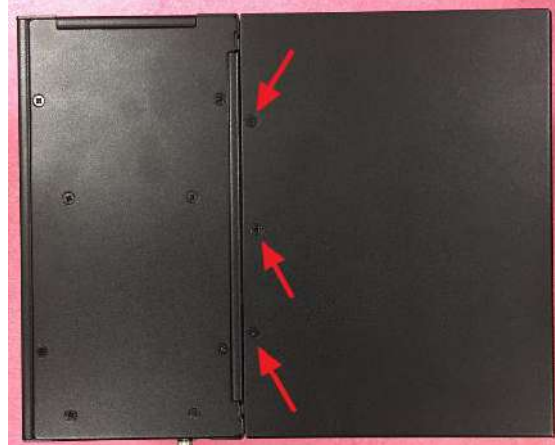

Step 14. Fix the screws of the expansion module



Step 15. Fix the screws of the expansion module



Step 16. Finish the installation of PCIe add-on card on WEBS-35C3 system





Install PCIe x 8 or x 16 add-on card on 2x PCIe x16 slots riser card

Step 1. Loosen the screws of the expansion module cover from bottom side



Step 2. Loosen the screws of the expansion module cover from right side



Step 3. Take out expansion module cover



Step 4. Check how to insert add-on card



Step 5. Loosen the screws of bracket



Step 6. Insert PCIe add-on card





Step 7. Screw bracket of PCIe add-on card



Step 8. Fix the screws of the expansion module cover from bottom side



Step 9. Fix the screws of the expansion module cover from right side



Step 10. Finish the installation of PCIe add-on card on WEBS-35C3 system

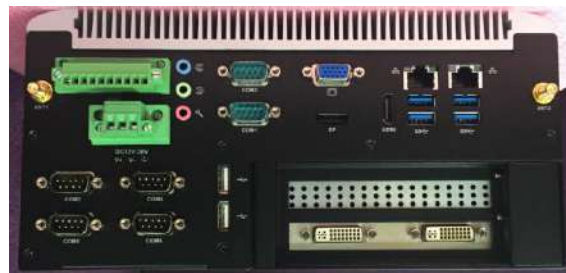

**Add-on card dimension limitation:**

Max dimension of add-on card in WEBS-35C3 is 176.65 x 113.9 mm.

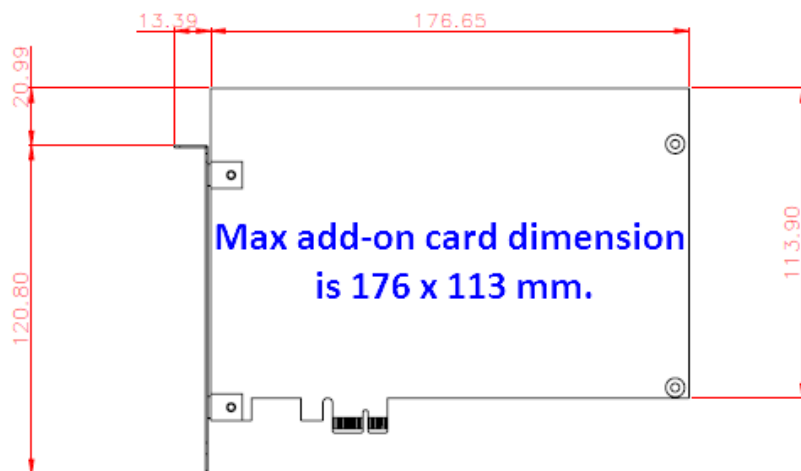

**The setting of PCIe x16 signal version with AS5-3463 only**

**J34: PCI Express Bifurcation**

ON=0; OFF=1

PEG Mode	PIN[1:2]
PCIe 1X8,2X4	00
<b>PCIe 2X8</b>	<b>10</b>
PCIe 1X16	11

## 2.4 I/O Interfaces

### 2.4.1 Front View



#### **Ext Power Switch:**

It is for remote system ON/OFF control.

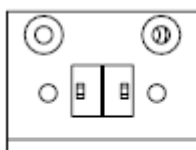

EXT  
PW SW

#### **Power Button:**

Press the power button to turn ON/OFF the system  
Blue color LED means Power on



#### **2.5\"**

Two removable 2.5\"

#### **Reset Button:**

Press the power button to reset the system

#### **HDD LED:**

It demonstrates HDD working status of the system.

### 2.4.2 Rear View



#### **DC in 12-36V via 3-pin terminal block connector:**

Provide power connection of the system to the main power source via DC power cable or AC/DC power adapter.

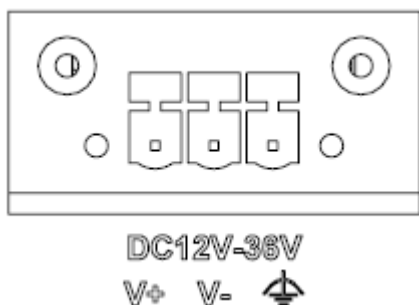

#### **ANT1 & ANT2 hole:**

Antenna holes for WiFi or 3G/GPS module

#### **GPIO:**

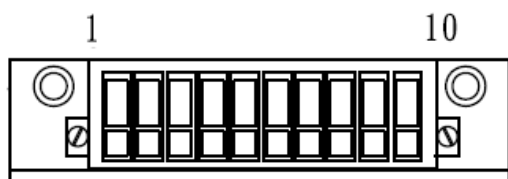

Pin	Signal	Pin	Signal
1	GPIO0	2	GPIO4
3	GPIO1	4	GPIO5
5	GPIO2	6	GPIO6
7	GPIO3	8	GPIO7
9	GND	10	VCC5

#### **Audio:**

Connectors for Mic-In, Line-In and Line-Out

**LAN:**

Two Gigabit Ethernet (10/100/1000 Mbits/sec) LAN ports by using Intel® I219LM & Intel® I211AT GbE Ethernet Controller

**USB3.0 & USB 2.0:**

Support six USB (Universal Serial Bus) ports, four USB 3.0 and two USB 2.0.

**VGA:**

VGA - CRT display output

**DP:**

DP (Display Port) display output

**HDMI:**

Type A HDMI display output

**COM port:**

## ● RS-232

Pin	Signal
1	DCD#
2	RXD#
3	TXD#
4	DTR#
5	GND
6	DSR#
7	RTS#
8	CTS#
9	RI#

## ● RS-232/4222/485

\*Note: RS-232/422/485 configuration is determined by BIOS setting. Check BIOS setting for details.

Pin	Signal
1	DCD#/DT-
2	RXD#/DT+
3	TXD#/422R+
4	DTR#/422R-
5	GND
6	DSR#
7	RTS#
8	CTS#
9	RI#



## 2.5 Getting Started

It is easy to get the system started.

Step 1. Make sure the power supply (12~36V) is connected properly



Step 2. Press the power button to turn on the system



## Chapter 3

### BIOS Setup Information

WEBS-3585 system adopts WADE-8017 mother board. WADE-8017 is equipped with the AMI BIOS stored in Flash ROM. These BIOS has a built-in Setup program that allows users to modify the basic system configuration easily. This type of information is stored in CMOS RAM so that it is retained during power-off periods. When system is turned on, WADE-8017 communicates with peripheral devices and checks its hardware resources against the configuration information stored in the CMOS memory. If any error is detected, or the CMOS parameters need to be initially defined, the diagnostic program will prompt the user to enter the SETUP program. Some errors are significant enough to abort the start-up.

#### 3.1 Entering Setup

Power on the computer and the system will start POST (Power on Self Test) process. When the message below appears on the screen, press <Delete> or <ESC> key will enter BIOS setup screen.

##### Press <Delete> or <ESC> to enter SETUP

If the message disappears before responding and still wish to enter Setup, please restart the system by turning it OFF and On or pressing the RESET button. It can be also restarted by pressing <Ctrl>, <Alt>, and <Delete> keys on keyboard simultaneously.

##### Press <F1> to Run General Help or Resume

The BIOS setup program provides a General Help screen. The menu can be easily called up from any menu by pressing <F1>. The Help screen lists all the possible keys to use and the selections for the highlighted item. Press <Esc> to exit the Help Screen.

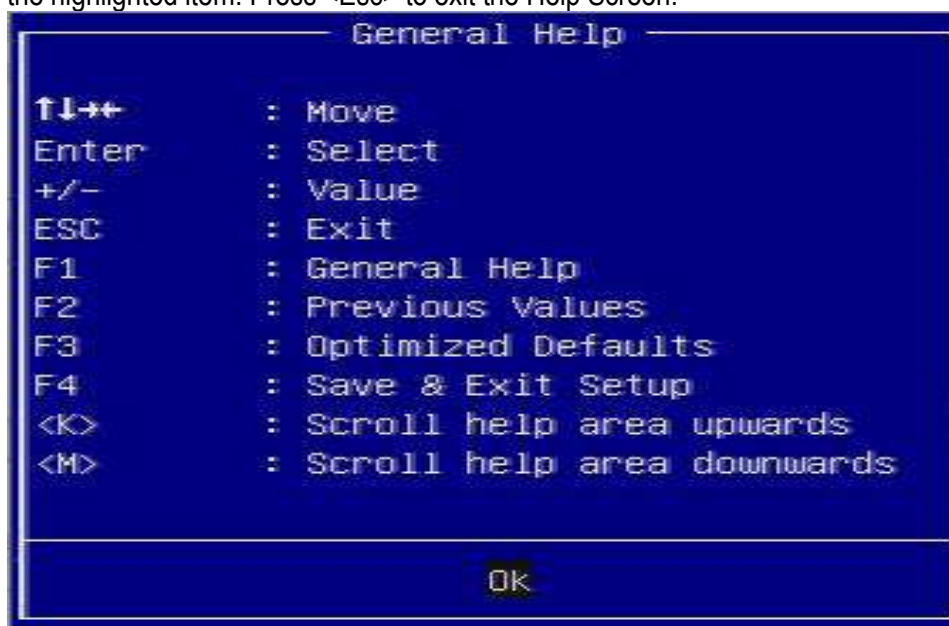



## 3.2 Main

Once you enter WADE-8017 AMI BIOS CMOS Setup Utility, a Main Menu is presented. The Main Menu allows user to select from eleven setup functions and two exit choices. Use arrow keys to switch among items and press <Enter> key to accept or bring up the sub-menu.

This setup page includes all the items in standard compatible BIOS. Use the arrow keys to highlight the item and then use the <PgUp>/<PgDn> or <+>/<-> keys to select the value or number you want in each item and press <Enter> key to certify it.

Follow command keys in CMOS Setup table to change Date, Time, Drive type, and Boot Sector Virus Protection Status.

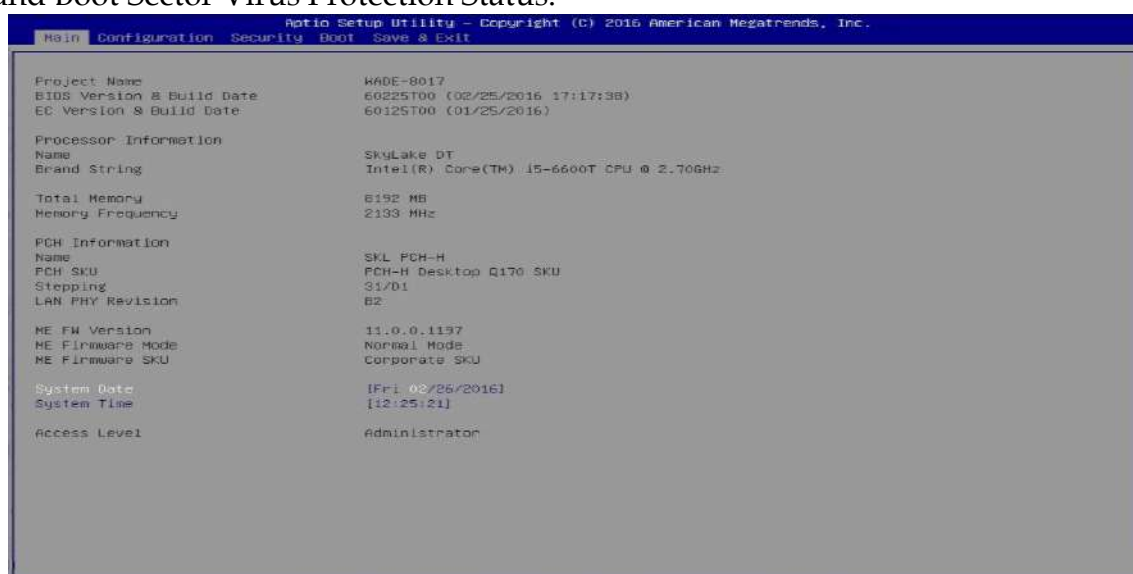

Feature	Description	Options
<b>System Date</b>	The date format is <Day>, <Month> <Date> <Year>. Use [ + ] or [ - ] to configure system Date.	
<b>System Time</b>	The time format is <Hour> <Minute> <Second>. Use [ + ] or [ - ] to configure system Time.	

### System Date

System date in the format [MM/DD/YYYY]. Use <Enter> or <Tab> to switch through the fields. Adjust the values with <+> and <->.

### System Time

System Time is in 24-Hour format [hh:mm:ss]. Use <Enter> or <Tab> to switch through the fields. Adjust the values with <+> and <->.

### 3.3 Configuration

Use this menu to set up the items of special enhanced features

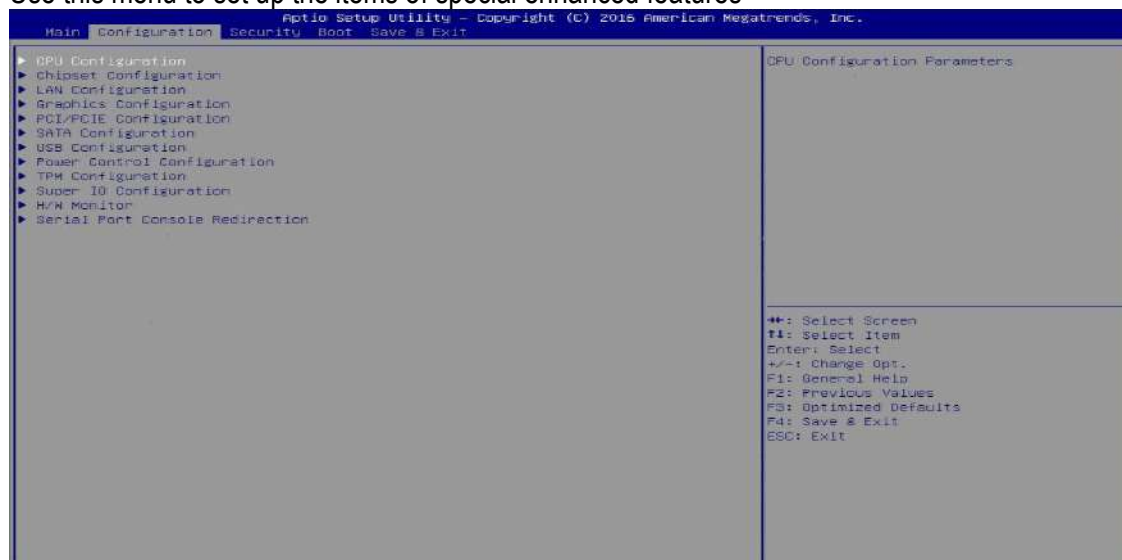

#### CPU Configuration

##### CPU Configuration Parameters

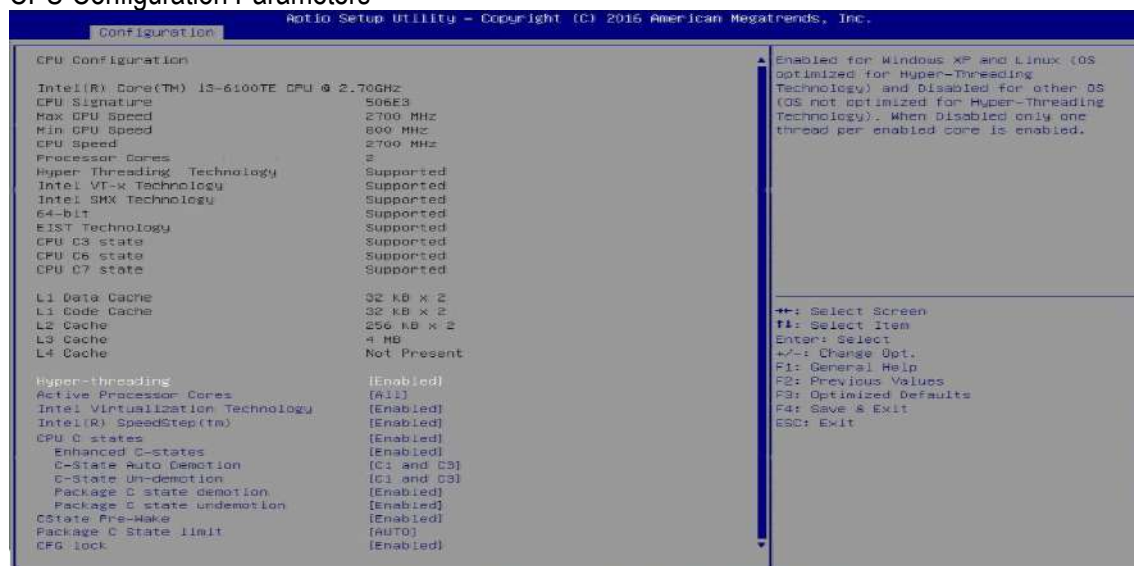

Feature	Description	Options
Active Processor Cores	Number of cores to enable in each processor package.	★All, 1, 2, 3
Intel Virtualization Technology	When enabled, a VMM can utilize the additional hardware capabilities provided by Vanderpool Technology.	★Enabled, Disabled
Intel® Speed Step™	Allows more than two frequency ranges to be supported.	★Enabled, Disabled
Turbo Mode	Turbo Mode.	★Enabled, Disabled
Configurable TDP Boot Mode	Configurable TDP Mode as Nominal /Up/ Down/ Deactivate TDP selection. Deactivate option will set MSR to Nominal and MMIO to Zero.	★Nominal, Down, Up, Deactivate

Configurable TDP Lock	Configurable TDP Mode Lock sets the Lock bits on TURBO_ACTIVATION_RATIO and CONFIG_TDP_CONTROL. Note: When CTDP Lock is enabled Custom ConfigTDP Count will be forced to 1 and Custom ConfigTDP Boot Index will be forced to 0.	★Disabled, Enabled
CTDP BIOS Control	Enables CTDP control via runtime ACPI BIOS methods. This “BIOS only” feature does not require EC or driver support.	★Disabled, Enabled
CPU C states (Enabled)	Enable or disable CPU C states	★Disabled, Enabled
Enhanced C-states	Enable/Disable C1E. When enabled, CPU will switch to minimum speed when all cores enter C-State.	Disabled, ★Enabled
C-State Auto Demotion	Configure C-State Auto Demotion.	Disabled, C1, C3, ★C1 and C3
C-State Un-demotion	Configure C-State Un-demotion.	Disabled, C1, C3, ★C1 and C3
Package C State demotion	Enable Package C state demotion.	Disabled, ★Enabled
Package C state un-demotion	Enable Package C state Un-demotion.	Disabled, ★Enabled
C State Pre-Wake	Disable – Sets bit 30 of POWER_CTL MSR(0x1FC) to 1 to disable the C State Pre-Wake	Disabled, ★Enabled
Package C State limit	Package C State limit	C0/C1, C2, C3, C6, C7, C7s, C8, ★AUTO
CFG lock	Configure MSR 0xE2[15], CFG lock bit.	Disabled, ★Enabled

## Chipset Configuration

### Configuration Chipset feature

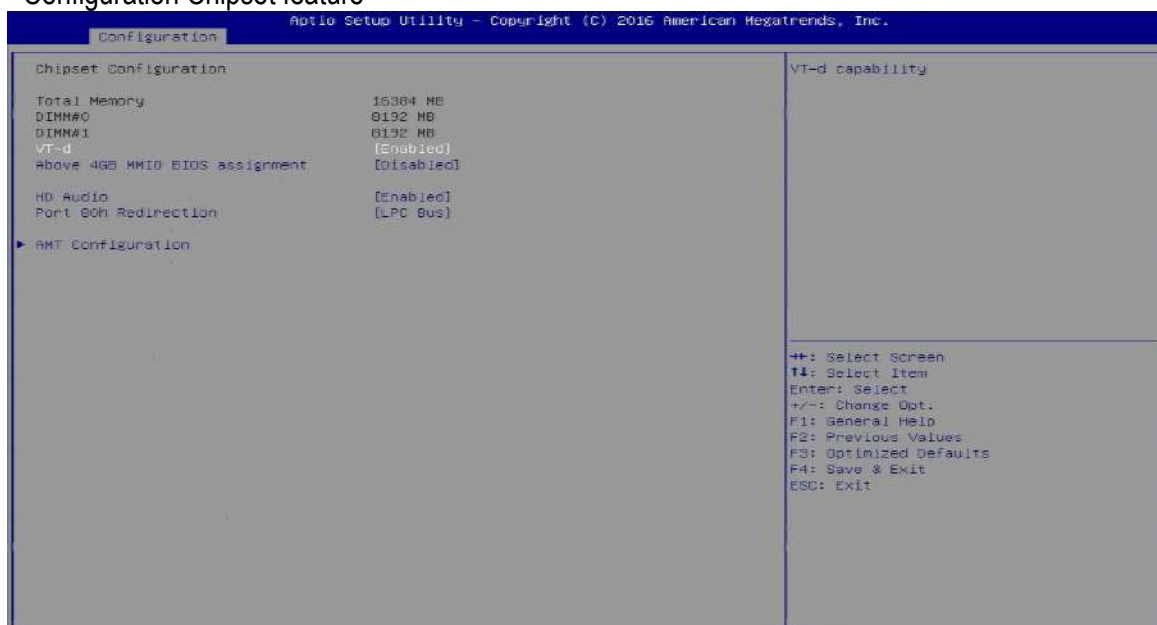

Feature	Description	Options
<b>VT-d</b>	VT-d capability	Disabled, ★Enabled
<b>Above 4GB MMIO BIOS assignment</b>	Enable/Disable above 4GB Memory Mapped IO BIOS assignment. This is disabled automatically when Aperture Size is set to 2048MB.	Enabled, ★Disabled
<b>HD Audio</b>	Control Detect of the HD-Audio device. Disabled = HAD will be unconditionally disabled Enabled = HAD will be unconditionally Enabled	Disabled, ★Enabled
<b>Port 80h Redirection</b>	Control where the port 80h cycles are sent.	★LPC Bus, PCIE Bus

### AMT Configuration

#### Configure Active Management Technology Parameters

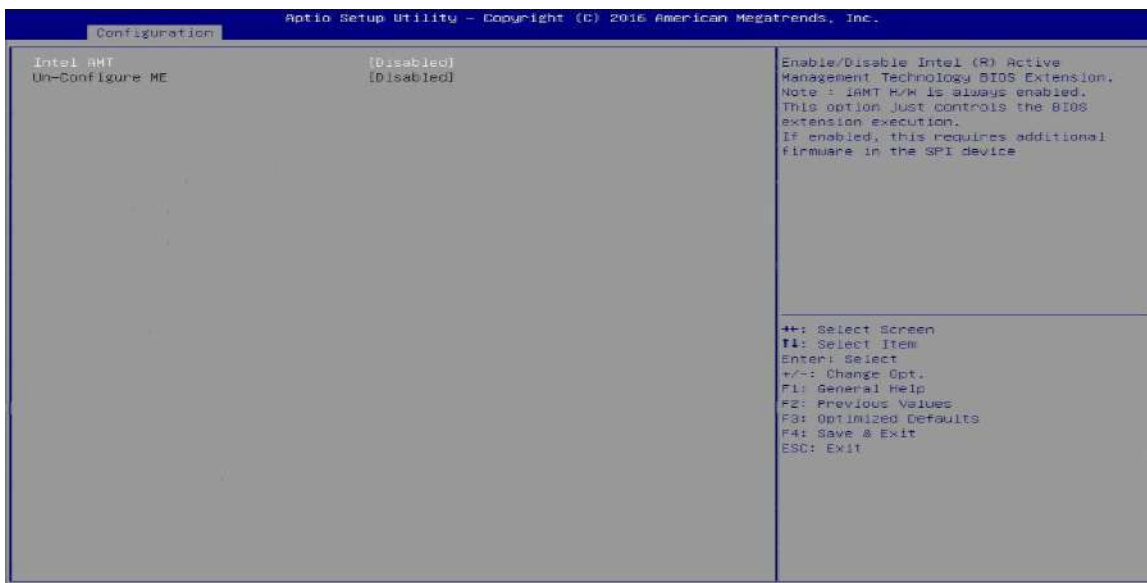

Feature	Description	Options
Intel AMT (Enabled)	Enable/Disable Intel ® Active Management Technology BIOS Extension. Note: iAMT H/W is always enabled. This option just controls the BIOS extension execution. If enabled, this requires additional firmware in the SPI device	★Disabled, Enabled
Un-Configure ME	OEMFlag Bit 15: Un-Configure ME without password.	★Disabled, Enabled

### LAN Configuration

#### Configuration on Board LAN device.

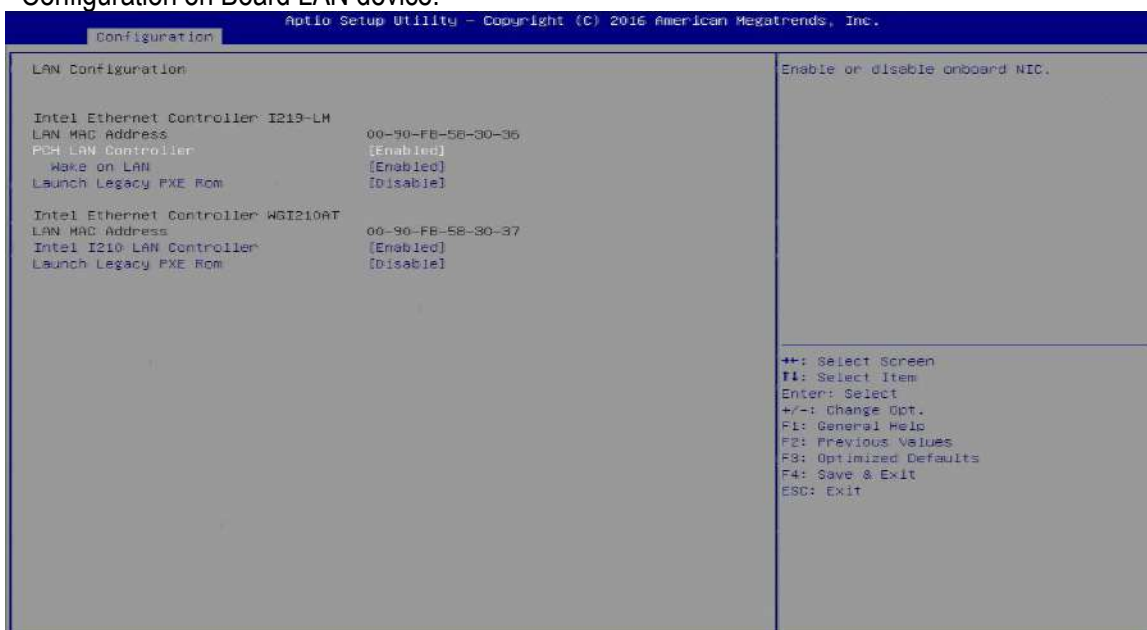

Feature	Description	Options
<b>PCH LAN Controller</b>	Enable or disable onboard NIC	★Enabled, Disabled
<b>Wake on LAN</b>	Enable or disable integrated LAN to wake the system. (The Wake On LAN cannot be disabled if ME is on at Sx state.)	★Enabled, Disabled
<b>Launch Legacy PXE Rom</b>	Launch Legacy PXE Rom. [Disable] Not launch Rom, [Enable] Force launch Rom, [Auto] Auto detect LAN Cable state to Enable/Disable Rom initial.	★Disable, Enable, Auto
<b>Intel I210 LAN Controller</b>	Intel I210 LAN Controller.	Disabled, ★Enabled
<b>Launch Legacy PXE Rom</b>	Launch Legacy PXE Rom. [Disable] Not launch Rom, [Enable] Force launch Rom, [Auto] Auto detect LAN Cable state to Enable/Disable Rom initial.	★Disable, Enable, Auto

## Graphics Configuration

### Configuration Graphics Settings

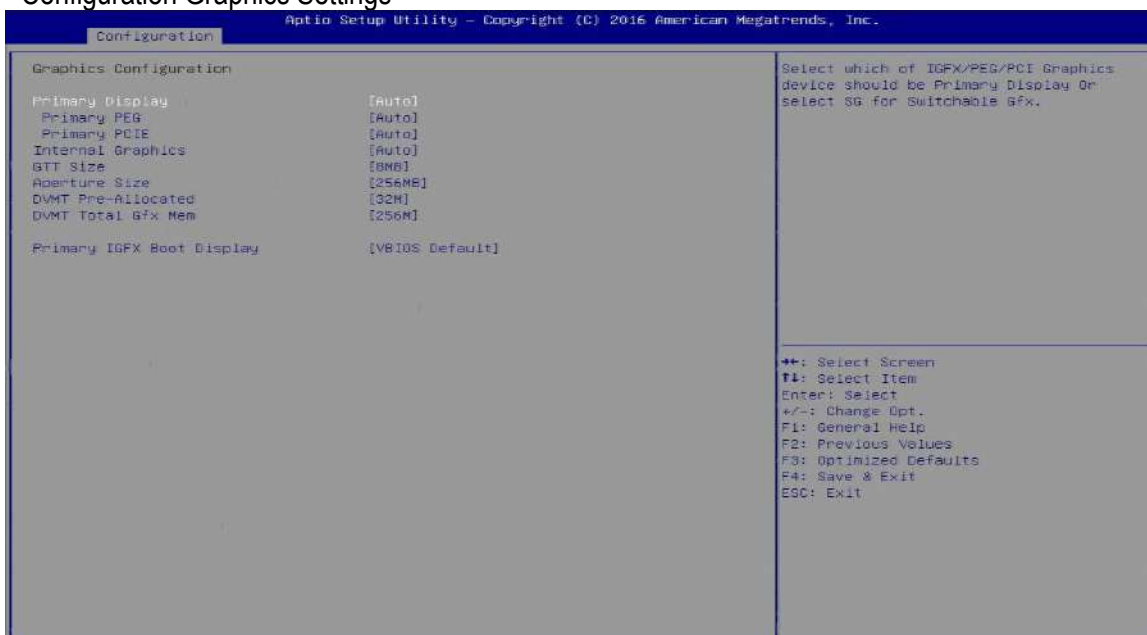

Feature	Description	Options
<b>Primary Display</b>	Select which of IGFX/PEG/PCI Graphics device should be Primary Display Or select SG for Switchable Gfx.	★Auto, IGFX, PEG, PCIE, SG
<b>Primary PEG</b>	Select Auto/PEG11/ PEG12 Graphics device should be Primary PEG.	★Auto, PEG11, PEG12
<b>Primary PCIE</b>	Select Auto/PCIE1/ PCIE2/ PCIE3/ PCIE4/ PCIE5/ PCIE6/ PCIE7/ of D28: F0/ F1/ F2/ F3/ F4/ F5/ F6/ F7, PCIE8/ PCIE9/ PCIE10/ PCIE11/ PCIE12/ PCIE13/ PCIE14/ PCIE15/ of D29: F0/ F1/ F2/ F3/ F4/ F5/ F6/ F7, PCIE16/ PCIE17/ PCIE18/ PCIE19 of D27: F0/ F1/ F2/ F3, Graphics device should be Primary PCIE.	★Auto, PCIE1, PCIE2, PCIE3, PCIE4, PCIE5, PCIE6, PCIE7, PCIE8, PCIE9, PCIE10, PCIE11, PCIE12, PCIE13, PCIE14, PCIE15, PCIE16, PCIE17, PCIE18, PCIE19,
<b>Internal Graphics</b>	Keep IGFX enable based on the setup options.	★Auto, Disabled, Enabled
<b>GTT Size</b>	Select the GTT Size	2MB, 4MB, ★8MB
<b>Aperture Size</b>	Select the Aperture Size Note: Above 4GB MMIO BIOS assignment is automatically enabled when selecting 2048MB aperture. To use this feature, please disable CSM Support.	128MB, ★256MB, 512MB, 1024MB, 2048MB, 4096MB
<b>DVMT Pre-Allocated</b>	Select DVMT 5.0 Pre-Allocated (Fixed Graphics Memory size used by the Internal Graphics Device.	★32M, 64M, 96M, 128M, 160M, 192M, 224M, 256M, 288M, 320M, 352M, 384M, 416M, 448M, 480M, 512

		M,1024M,1536M,2048 M,4M,8M,12M,16M,20M,24M,28M,32M,/F7,36M,40M,44M,48M,52M,56M
<b>DVMT Total Gfx Mem</b>	Select DVMT5.0 Total Graphic Memory size used by the Internal Graphics Device	128M, ★256,MAX
<b>Primary IGFX Boot Display</b>	Select the Video Device which will be activated during POST. This has no effect if external graphics present. Secondary boot display selection will appear based on your selection. VGA modes will be supported only on primary display	★VBIOS Default, DP, VGA, HDMI
<b>Secondary IGFX Boot Display</b>	Select Secondary Display Device	★Disabled, DP, VGA, HDMI

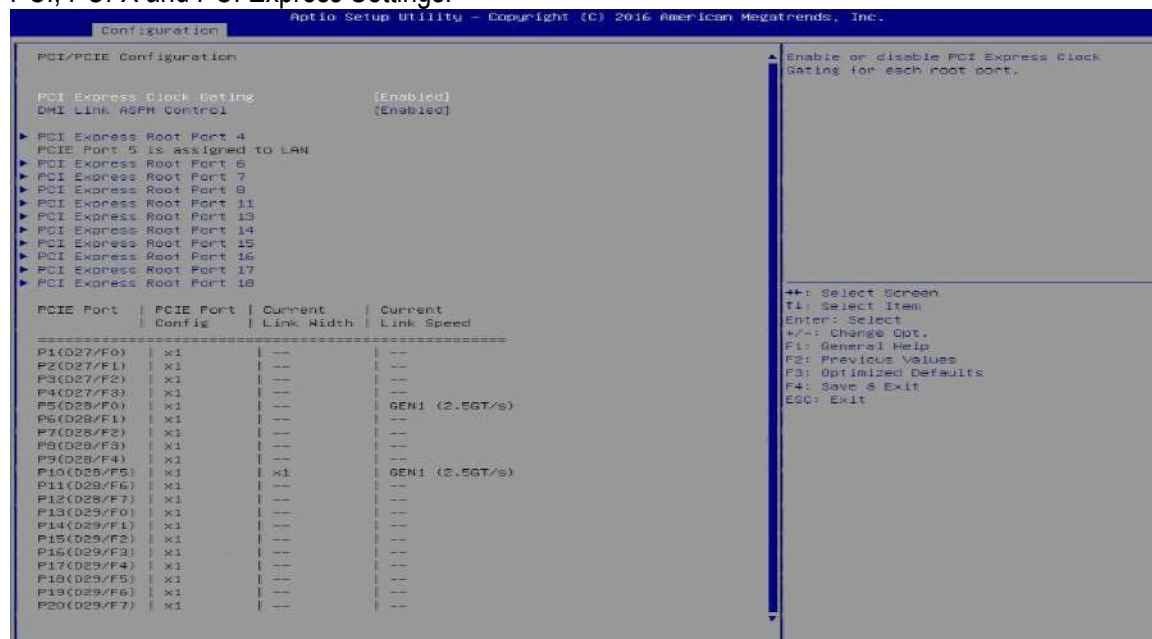

**PCI/PCIE Configuration****PCI, PCI-X and PCI Express Settings.**

Feature	Description	Options
<b>PCI Express Clock Gating</b>	Enable or disable PCI Express Clock Gating for each root port.	Disabled ★Enabled
<b>DMI Link ASPM Control</b>	Enable/Disable the control of Active State Power Management on SA side of the DMI Link.	Disabled ★Enabled

### PCI Express Root Port4, 6-8, 11, 13-18

### PCI Express Root Port 4, 6-8, 11, 13-18

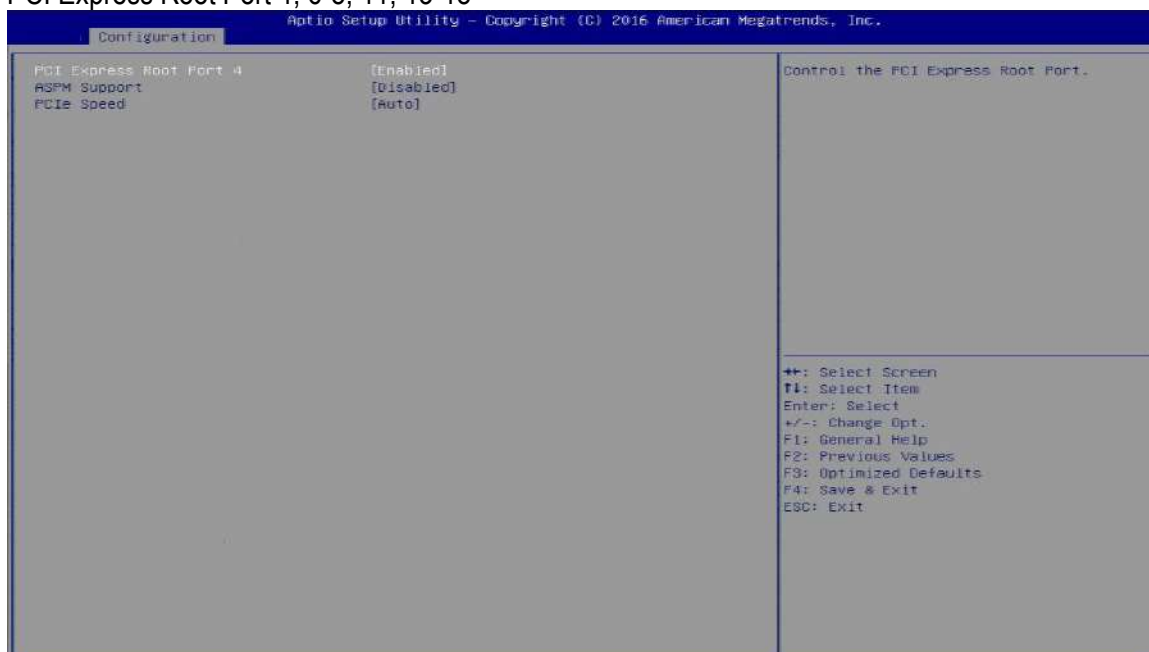

Feature	Description	Options
<b>PCI Express Root Port 4, 6-8, 11, 13-18</b>	Control the PCI Express Root Port.	Disabled, ★Enabled
<b>ASPM Support</b>	Set the ASPM Level: Force L0s – Force all links to L0s State AUTO-BIOS auto configure, DISABLE – Disables ASPM	★Disabled, L0s, L1, L0sL1, Auto
<b>PCIe Speed</b>	Select PCI Express port speed	★Auto, Gen1, Gen2, Gen3

## SATA Configuration

### SATA Device Options Settings

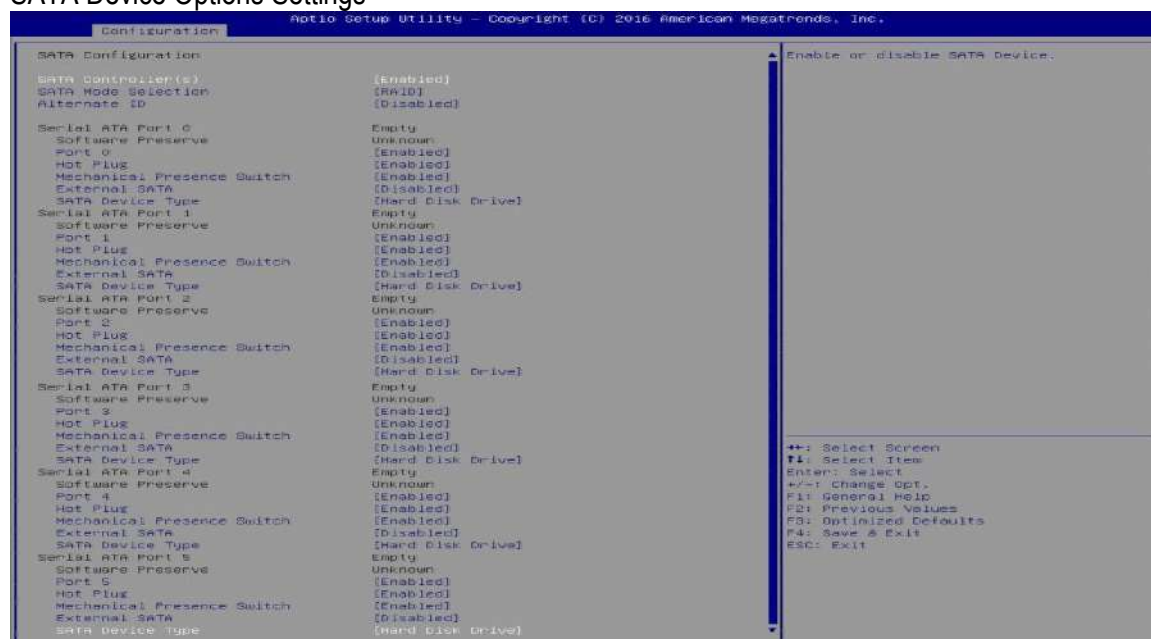

Feature	Description	Options
<b>SATA Controller(s)</b>	Enable or disable SATA Device.	★Enabled, Disabled
<b>SATA Mode Selection</b>	Determines how SATA controller(s) operate.	★AHCI, RAID
<b>Port 0-5</b>	Enable or Disable SATA Port	Disabled, ★Enable
<b>Hot Plug</b>	Designates this port as Hot Pluggable	★Disabled, Enabled
<b>External SATA</b>	External SATA Support.	★Disabled, Enabled
<b>SATA Device Type</b>	Identify the SATA port is connected to Solid State Drive or Hard Disk Drive.	★hard Disk Drive, Solid State Drive

## USB Configuration

### USB Configuration Parameters.

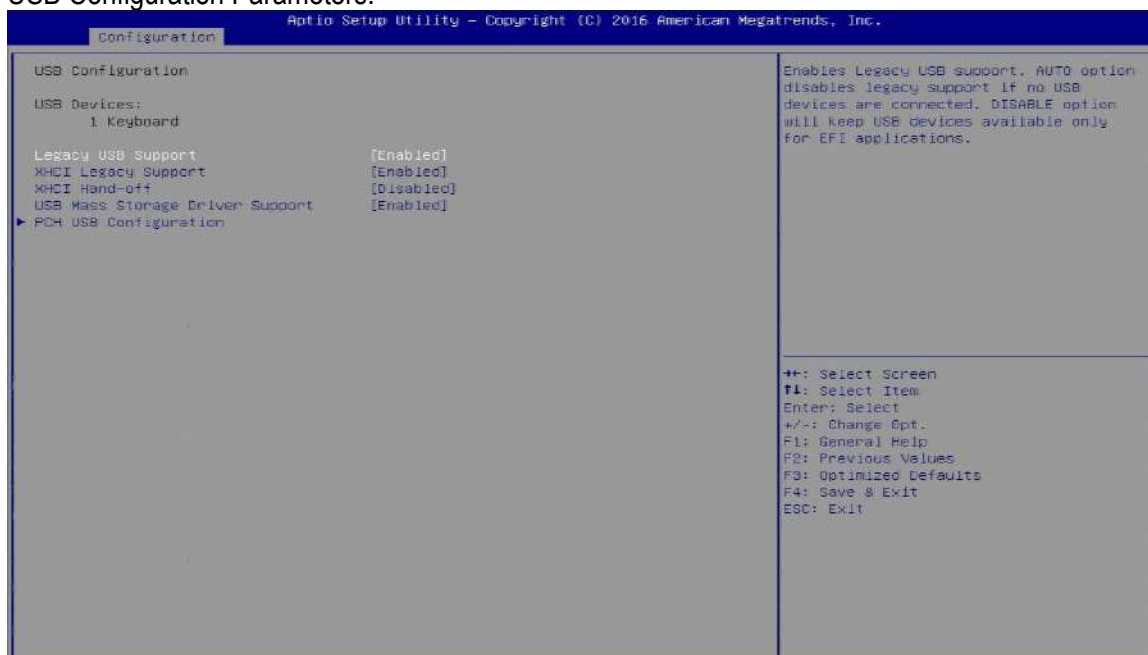

Feature	Description	Options
<b>Legacy USB Support</b>	Enables Legacy USB support. AUTO option disables legacy support if no USB Devices are connected. DISBLE option will keep USB devices available only for EFI applications.	★Enabled, Disabled, Auto
<b>XHCI Legacy Support</b>	Enable/Disable XHCI Controller Legacy support.	★Enable, Disabled
<b>XHCI Hand-off</b>	This is workaround for OSes without XHCI hand-off support. The XHCI ownership change should be claimed by XHCI driver.	Enabled, ★Disabled
<b>USB Mass Storage Driver Support</b>	Enable/Disable USB Mass Storage Driver Support.	Disabled, ★Enabled

## PCH USB Configuration

### PCH USB Configuration

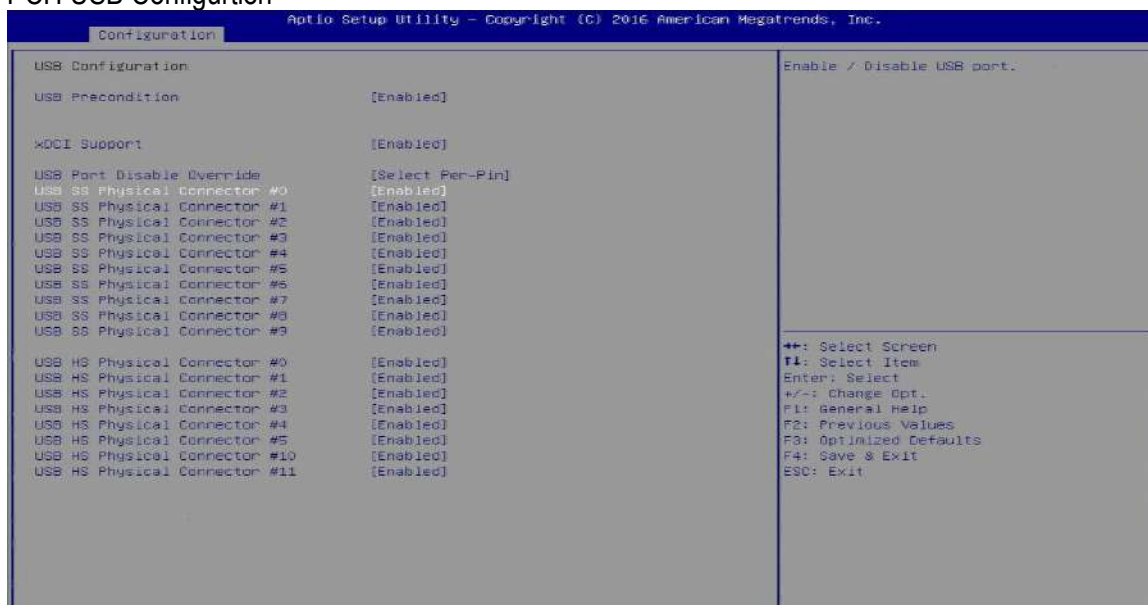

Feature	Description	Options
<b>USB Precondition</b>	Precondition work on USB host controller and root ports for faster Enumeration.	Enabled, ★Disabled
<b>xDCI Support</b>	Enable/Disable xDCI (USB OTG Device).	★Disabled, Enabled
<b>USB Port Disable Override</b> (Select Per-Pin)	Selectively Enable/Disable the corresponding USB port from reporting a Device Connection to the controller.	★Disabled, Select Per-Pin
<b>USB SS Physical Connector #0-9</b>	Enable /Disable USB port.	★Enabled, Disabled
<b>USB HS Physical Connector #0-5, 10-11</b>	Precondition work on USB host controller and root ports for faster enumeration.	Disabled, ★Enabled

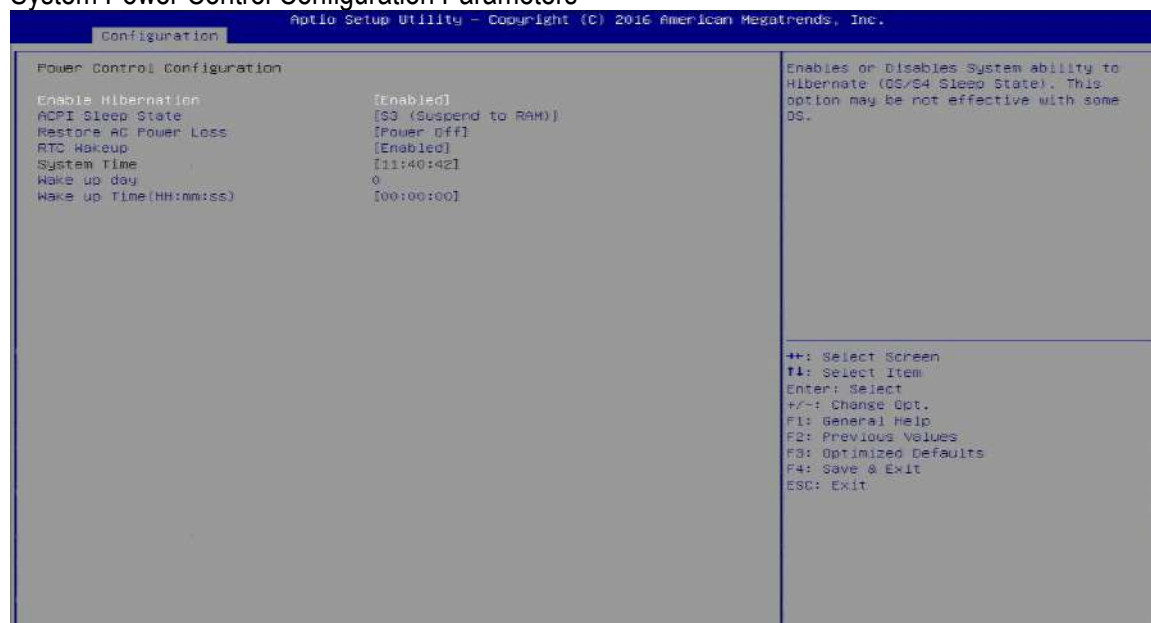
**Power Control Configuration****System Power Control Configuration Parameters**

Feature	Description	Options
<b>Enable Hibernation</b>	Enables or Disables System ability to Hibernate (OS/S4 Sleep State). This option may be not effective with some OS.	Disabled, ★Enabled
<b>ACPI Sleep State</b>	Select the highest ACPI sleep state the system will enter when the SUSPEND button is pressed.	Suspend Disabled, ★S3 (Suspend to RAM)
<b>Restore AC Power Loss</b>	Specify what state to go to when power is re-applied after a power failure (G3 state)	Power On, ★Power Off
<b>RTC Wake up (Enabled)</b>	Enable or disable System wake on alarm event. [Enabled], system will wake up the Hour: Min: Sec specified. [Disabled] Turn off RTC Wakeup.	★Disabled, Enabled
<b>Wake up day</b>	Select 0 for daily system wake up 1-31 for which day of the month that you would like the system to wake up	
<b>Wake up Time(HH: mm: ss)</b>	Use [Enter], [TAB] to select field, HH: 0-23, mm: 0-59, ss: 0-59	

## TPM Configuration

### Trusted Computing settings

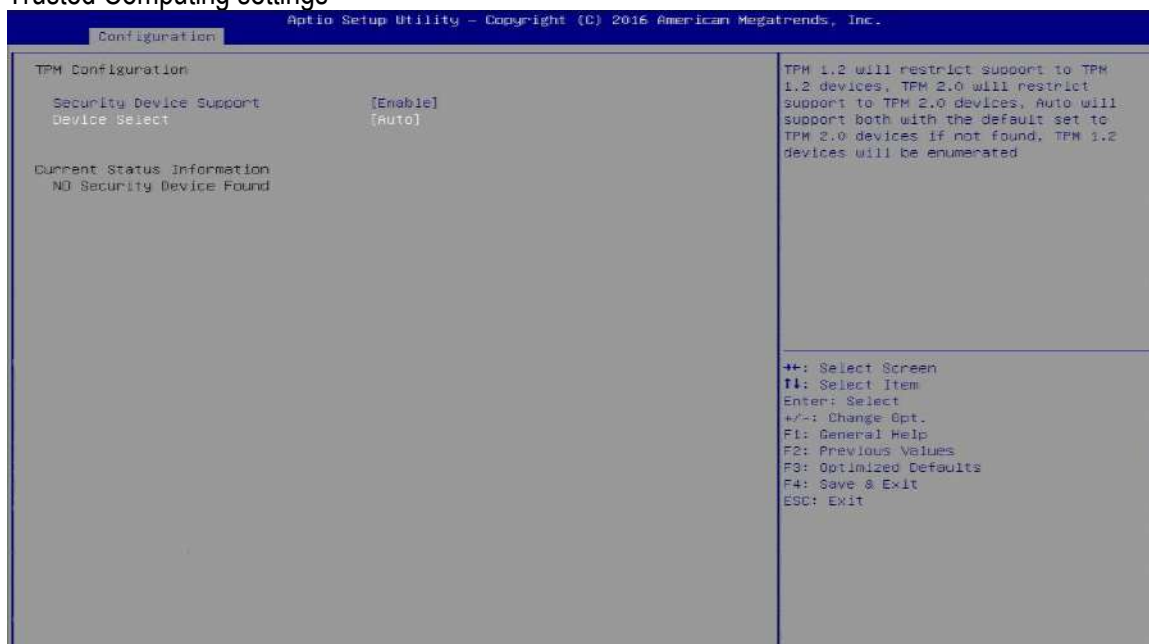

Feature	Description	Options
<b>Security Device Support</b> (Enabled)	Enables or Disables BIOS support for security device. O.S. will not show Security Device. TCG EFI protocol and INT1A Interface will not be available.	★Disabled, Enabled
<b>Device Select</b>	TPM 1.2 will restrict support to TPM 1.2 devices, TPM 2.0 will restrict support to TPM 2.0 devices, Auto will support both with the default set to TPM 2.0 devices if not found, TPM 1.2 devices will be enumerated.	TPM 1.2, TPM 2.0, ★Auto

## Super IO Configuration

### System Super IO Chip Parameters.

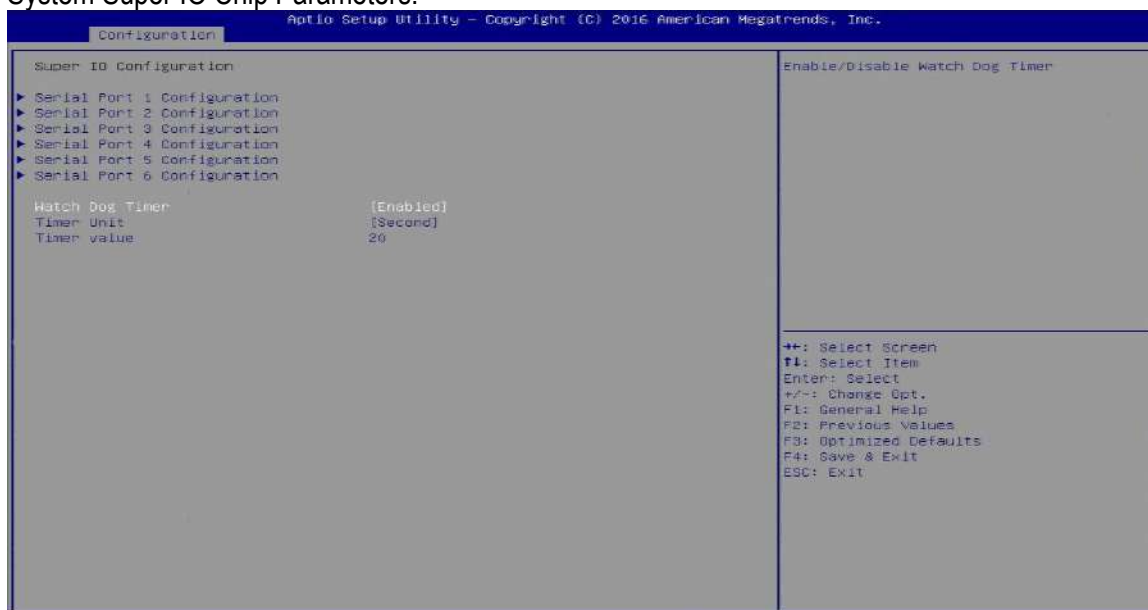

Feature	Description	Options
<b>Watch Dog Timer</b> (Enabled)	Enable/Disable Watch Dog Timer	★Disabled, Enabled
<b>Timer Unit</b>	Select Timer count unit of WDT	★Second, Minute
<b>Timer value</b>	Set WDT Timer value	★20



## Serial Port 1 Configuration

### Set Parameters of Serial Port 1 (COMA)



Feature	Description	Options
<b>Serial Port</b>	Enable or Disable Serial Port (COM)	Disabled, ★Enabled
<b>Change Settings</b>	Select an optimal settings for Super IO Device	★Auto, IO=3F8h; IRQ=4; IO=3F8h; IRQ=3,4,5,6,7,9,10,11,12 IO=2F8h; IRQ=3,4,5,6,7,9,10,11,12 IO=3E8h; IRQ=3,4,5,6,7,9,10,11,12 IO=2E8h; IRQ=3,4,5,6,7,9,10,11,12

### Serial Port 2 Configuration

#### Set Parameters of Serial Port 2 (COMB)

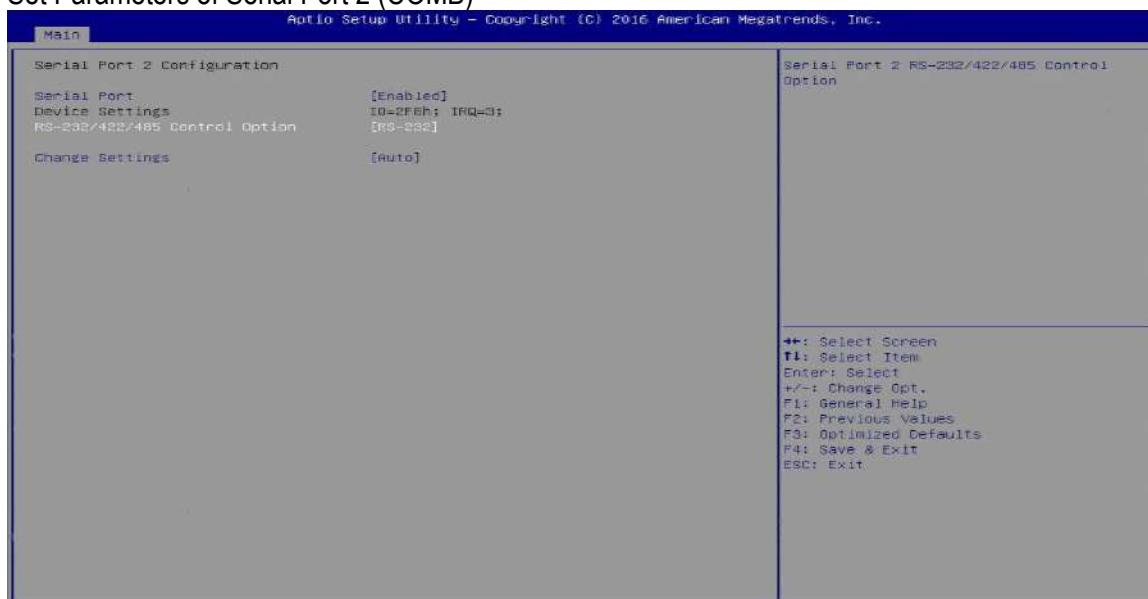

Feature	Description	Options
<b>Serial Port</b>	Enable or Disable Serial Port (COM)	Disabled, ★Enabled
<b>RS-232/422/485 Control Option</b>	Serial Port 2 RS-232/422/485 Control Option	★RS-232, RS-485 HALF DUPLEX, RS-485/422 FULL DUPLEX
<b>Change Settings</b>	Select an <b>optimal</b> settings for Super IO Device.	★Auto, IO=2F8h; IRQ=3; IO=3F8h; IRQ=3,4,5,6,7,9,10,11,12 IO=2F8h; IRQ=3,4,5,6,7,9,10,11,12 IO=3E8h;IRQ=3,4,5,6,7,9,10,11,12 IO=2E8h;IRQ=3,4,5,6,7,9,10,11,12

### Serial Port 3 Configuration

#### Set Parameters of Serial Port 3 (COMC)

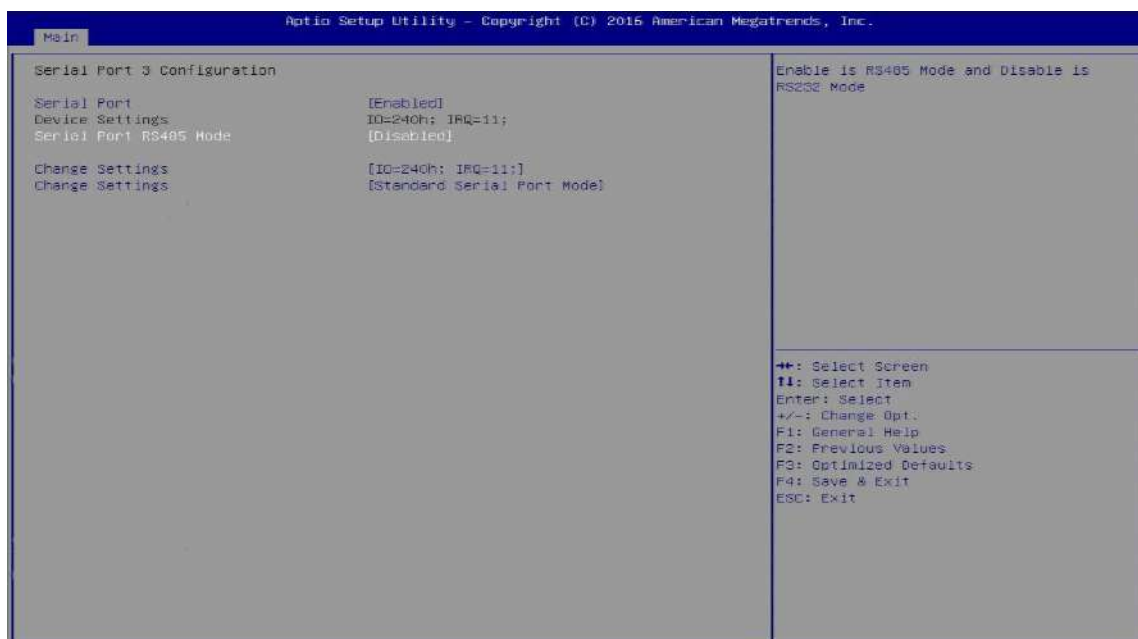

Feature	Description	Options
<b>Serial Port</b>	Enable or Disable Serial Port (COM)	Disabled, ★Enabled
<b>Serial Port RS-485 Mode</b>	Enabled is RS485 Mode and Disable is RS232 Mode	★Disabled, Enabled
<b>Change Settings</b>	Select an optimal setting for Super IO Device.	Auto, ★IO=240h; IRQ=11, IO=240h; IRQ=3,4,5,6,7,10,11,12 IO=248h; IRQ=3,4,5,6,7,10,11,12 IO=250h; IRQ=3,4,5,6,7,10,11,12 IO=258h; IRQ=3,4,5,6,7,10,11,12
<b>Change Settings</b>	Select an optimal setting for Super IO Device	★Standard Serial Port Mode, IrDA Active pulse 1.6 uS, Full Duplex, IrDA Active pulse 1.6 uS, Half Duplex, IrDA Active pulse 3/16 bit time, Full Duplex, IrDA Active pulse 3/16 bit time, Half Duplex

## Serial Port 4 Configuration

### Set Parameters of Serial Port 4 (COMD)

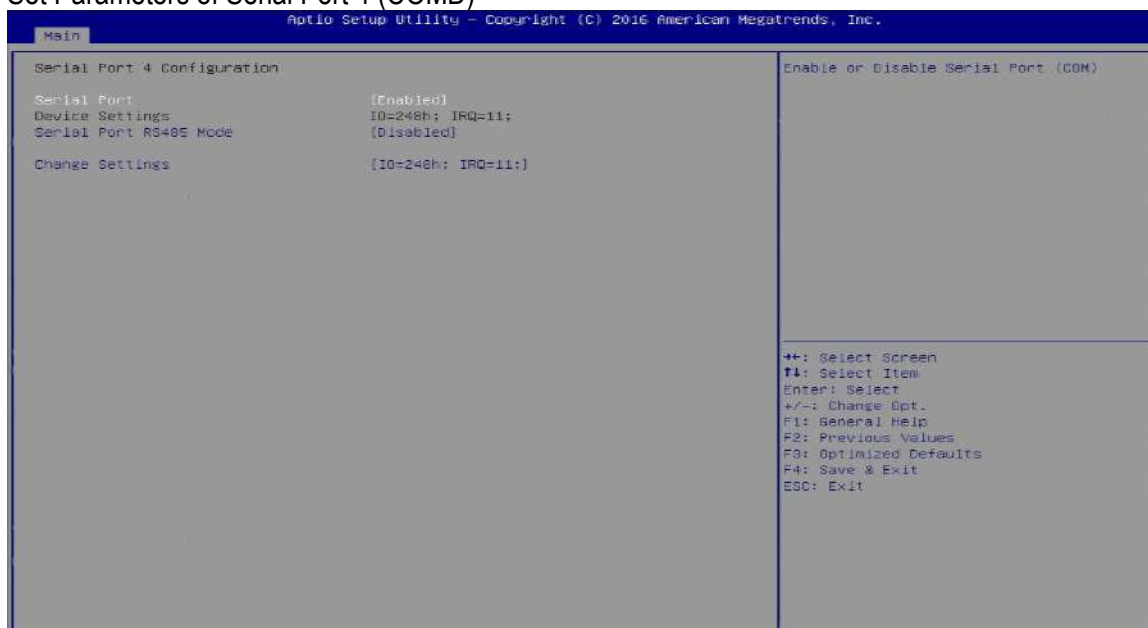

Feature	Description	Options
<b>Serial Port</b>	Enable or Disable Serial Port (COM)	Disabled, ★Enabled
<b>Serial Port RS485 Mode</b>	Enable is RS485 Mode and Disable is RS232 Mode	★Disabled, Enabled
<b>Change Settings</b>	Select an optimal settings for super IO Device	Auto, ★IO=248h; IRQ=11, IO=240h; IRQ=3,4,5,6,7,10,11,12; IO=248h; IRQ=3,4,5,6,7,10,11,12; IO=250h; IRQ=3,4,5,6,7,10,11,12; IO=258h; IRQ=3,4,5,6,7,10,11,12;

## Serial Port 5 Configuration

### Set Parameters of Serial Port 5 (COM5)

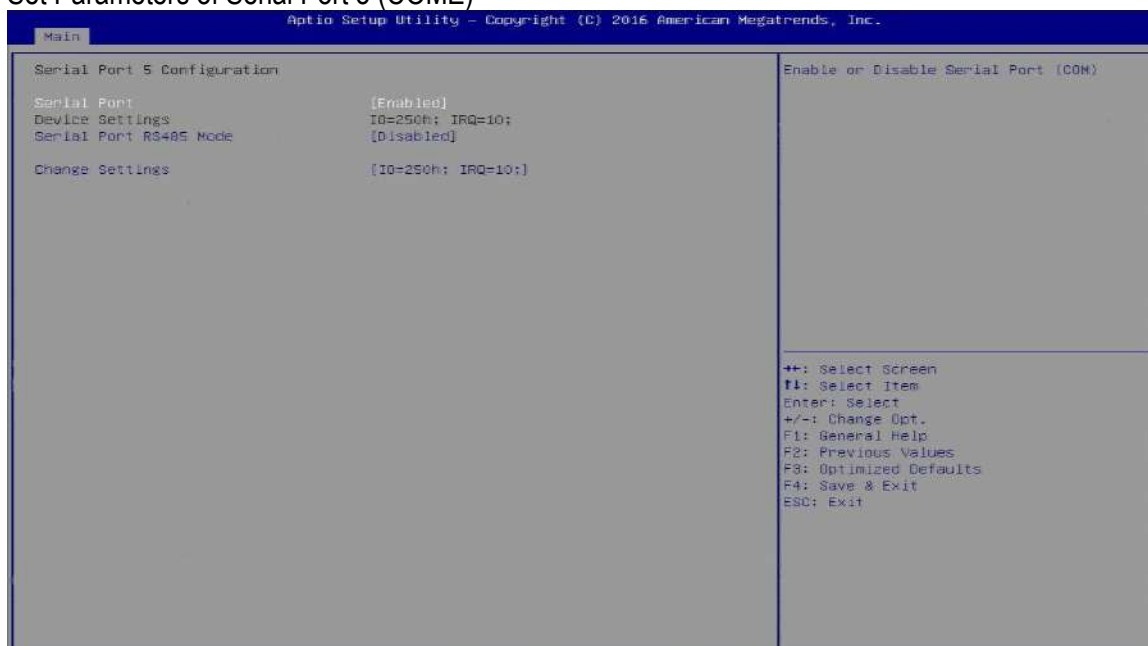

Feature	Description	Options
<b>Serial Port</b>	Enable or Disable Serial Port (COM)	Disabled, ★Enabled
<b>Serial Port RS485 Mode</b>	Enable is RS485 Mode and Disable is RS232 Mode	★Disabled, Enabled
<b>Change Settings</b>	Select an optimal settings for super IO Device	Auto, ★IO=250h; IRQ=10, IO=240h; IRQ=3,4,5,6,7,10,11,12; IO=248h; IRQ=3,4,5,6,7,10,11,12; IO=250h; IRQ=3,4,5,6,7,10,11,12; IO=258h; IRQ=3,4,5,6,7,10,11,12;

## Serial Port 6 Configuration

### Set Parameters of Serial Port 6 (COMF)

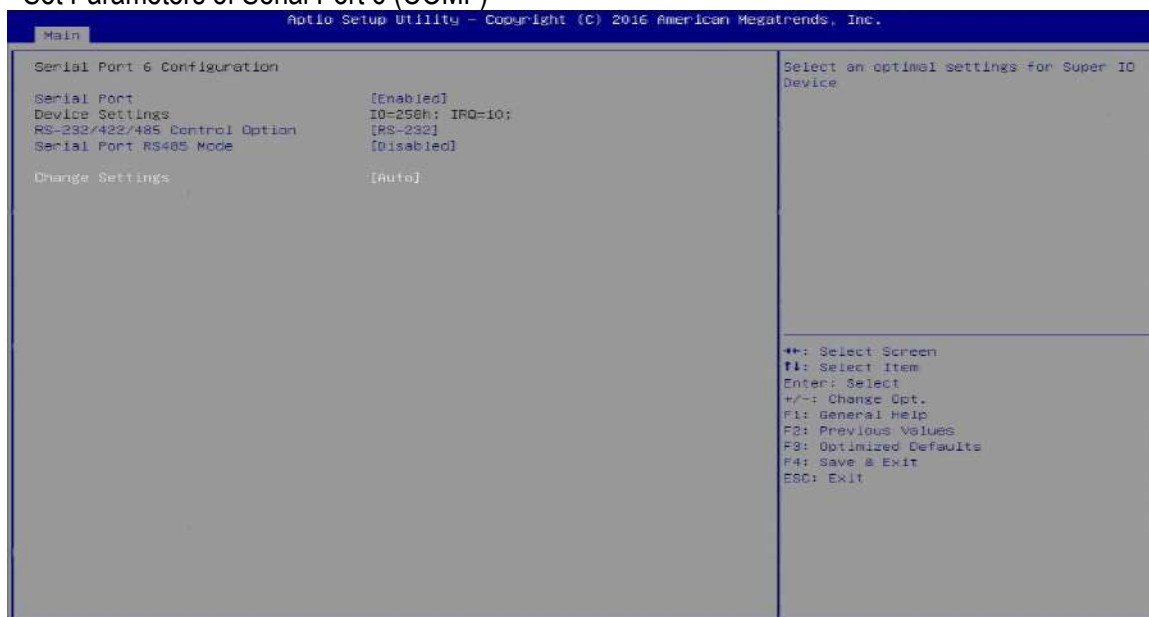

Feature	Description	Options
<b>Serial Port</b>	Enable or Disable Serial Port (COM)	Disabled, ★Enabled
<b>RS-232/422/485 Control Option</b>	Serial Port 6 RS-232/422/485 Control Option	★RS-232, RS-485 HALF DUPLEX, RS-485/422 FULL DUPLEX
<b>Serial Port RS485 Mode</b>	Enable is RS485 Mode and Disable is RS232 Mode	★Disabled, Enabled
<b>Change Settings</b>	Select an optimal settings for Super IO Device	Auto, ★IO=258h; IRQ=10, IO=240h; IRQ=3,4,5,6,7,10,11,12; IO=248h; IRQ=3,4,5,6,7,10,11,12; IO=250h; IRQ=3,4,5,6,7,10,11,12; IO=258h; IRQ=3,4,5,6,7,10,11,12;

## H/W Monitor Configuration

### Monitor hardware status

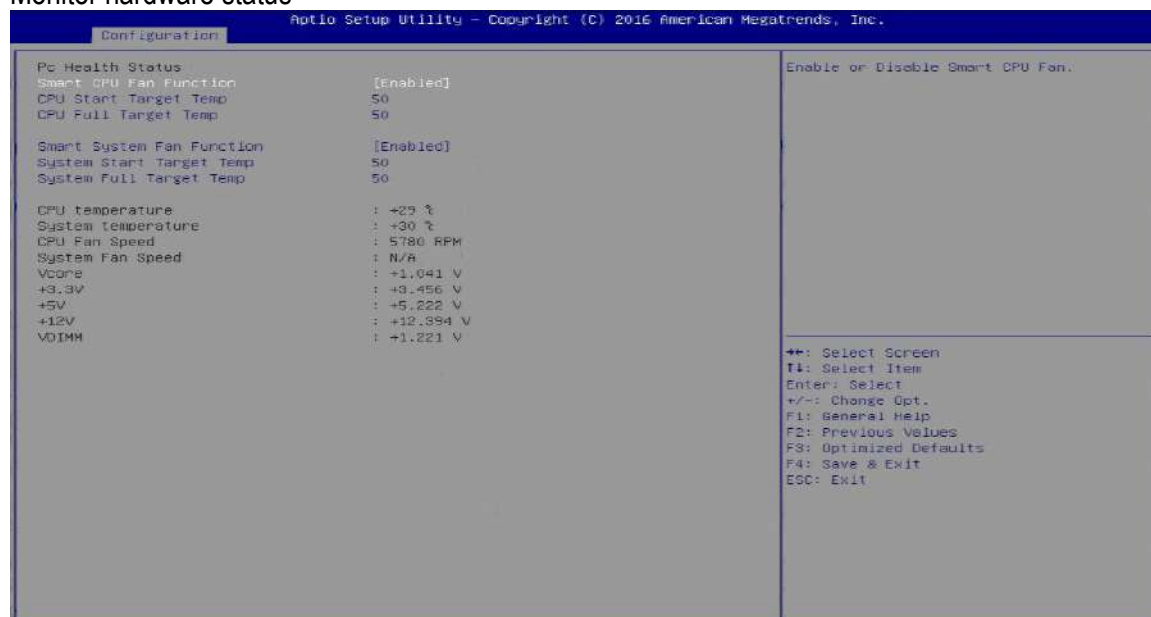

Feature	Description	Options
<b>Smart CPU Fan Function (Enabled)</b>	Enable or Disable Smart CPU Fan	★Disabled, Enabled
<b>CPU Start Target Temp</b>	CPU Start Fan Target Temperature.	50
<b>CPU Full Target Temp</b>	CPU Full Fan Target Temperature.	50
<b>Smart System Fan Function</b>	Enable or Disable Smart System Fan	★Disabled, Enabled
<b>System Start Target Temp</b>	System Start Fan Target Temperature.	50
<b>System Full Target Temp</b>	System Full Fan Target Temperature.	50

## Serial Port Console Redirection

### Serial Port Console Redirection

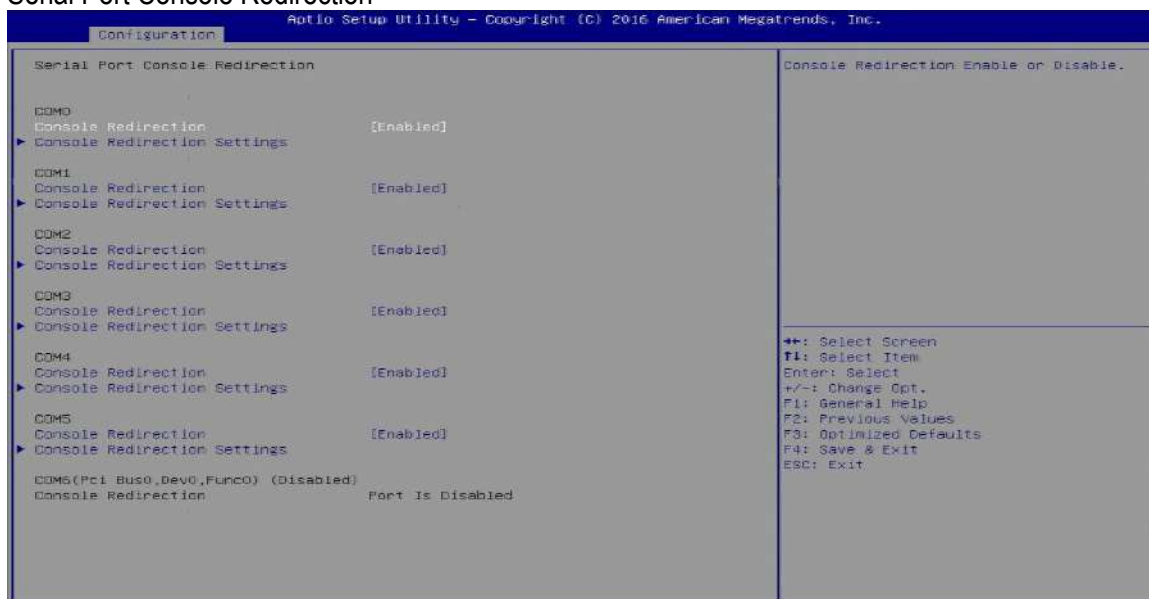

Feature	Description	Options
Console Redirection (COM 0-5) (Enabled)	Console Redirection Enable or Disable.	★ Disabled, Enabled



## COM 0-5 Serial Port Console Redirection

### Serial Port Console Redirection

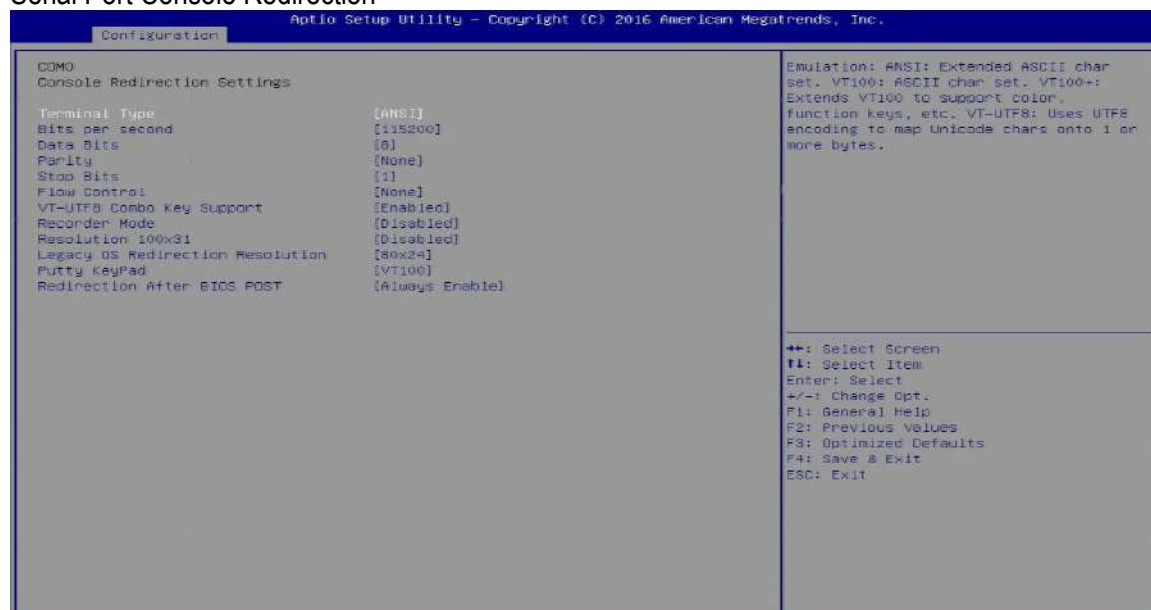

Feature	Description	Options
<b>Terminal Type</b>	Emulation: ANSI: Extended ASCII char set. VT100: ASCII char set. VT100+: Extends VT100 to support color, function keys, etc. VT-UTF8: Uses UTF8 encoding to map Unicode chars onto 1 or more bytes.	VT100, VT100+, VT-UTF8, ★ANSI
<b>Bits per second</b>	Select Serial port transmission speed. The speed must be matched on other side. Long or noisy lines may require lower speeds.	9600, 19200, 38400, 57600, ★115200
<b>Data bits</b>	Data bits	7, ★8
<b>Parity</b>	A parity bit can be sent with the data bits to detect some transmission errors. Even: parity bit is 0 if the num of 1's in the data bits is even. Odd: parity bit is 0 if num of 1's in the data bits is odd. Mark: parity bit is always 1. Space parity bit is always 0. Mark and Space Parity do not allow for error detection. They can be used as an additional data bit.	★None, Even, Odd, Mark, Space
<b>Stop Bits</b>	Stop bits indicate the end of a serial data packet. (A start bit indicates the beginning). The standard setting is 1 stop bit.	★1,2

	Communication with slow devices may require more than 1 stop bit.	
<b>Flow Control</b>	Flow control can prevent data loss from buffer overflow. When sending data, if the receiving buffers are full, a 'stop' signal can be sent to stop the data flow. Once the buffers are empty, a 'start' signal can be sent to re-start the flow. Hardware flow control uses two wires to send start/stop signal.	★None, Hardware RTS/CTS
<b>VT-UTF8 Combo Key Support</b>	Enable VT-UTF8 Combination Key Support for ANSI/VT100 terminals	Disabled, ★Enabled
<b>Recorder Mode</b>	With this mode enabled only text will be sent. This is to capture Terminal data.	★Disabled, Enabled
<b>Resolution 100x31</b>	Enables or disables extended terminal resolution	★Disabled, Enabled
<b>Legacy OS Redirection Resolution</b>	On Legacy OS, the Number of Rows and Columns supports redirection	★80x24, 80x25
<b>Putty KeyPad</b>	Select FunctionKey and KeyPad on Putty	★VT100, LINUX,XTERMR6, SCO,ESCN,VT400
<b>Redirection After BIOS POST</b>	The settings specify if BootLoader is selected then Legacy console redirection is disabled before booting to legacy OS. Default value is Always Enable with means Legacy console Redirection is enabled for Legacy OS.	★Always Enable, BootLoader

### 3.4 Security

This section lets you set security passwords to control access to the system at boot time and/or when entering the BIOS setup program.

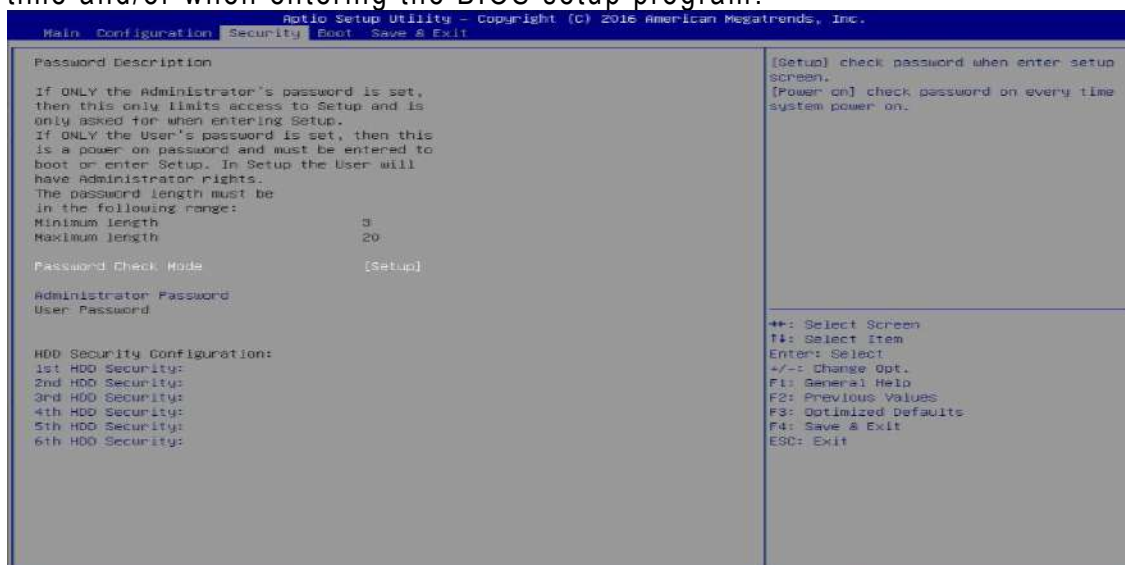

Feature	Description	Options
<b>Password Check Mode</b>	[Setup] check password when enter setup screen. [Power on] check password on every time system power on.	★Setup, Power on
<b>Administrator Password</b>	Set Administrator Password	
<b>1st-6th HDD Security</b>	HDD Security Configuration for selected drive.	

### 3.5 Boot

Use this menu to specify the priority of boot devices.



Feature	Description	Options
<b>Bootup NumLock State</b>	Select the keyboard NumLock state	★On, Off
<b>GateA20 Active</b>	UPON REQUEST – GA20 can be disabled, using BIOS services. ALWAYS – do not allow disabling GA20; this option is useful when any RT code is executed above 1MB.	★Upon Request, Always
<b>Option ROM Messages</b>	Set display mode for Option ROM	★Force BIOS, Keep Current
<b>Storage</b>	Controls the execution of the UEFI and Legacy Storage OpROM	Do not Launch, UEFI, ★Legacy
<b>Full screen Logo</b>	Enables or disables Quiet Boot option and Full screen Logo.	★Disabled, Enabled
<b>Post Report</b>	Post Report Support Enabled/Disabled	★Disabled, Enabled
<b>Summary Screen</b>	Summary Screen Support Enabled/Disabled	★Disabled, Enabled
<b>Fast Boot</b>	Enables or disables boot with initialization of a minimal set of devices required to launch active boot option. Has no effect for BBS boot options.	★Disabled, Enabled
<b>Boot option filter</b>	This option controls Legacy/UEFI ROMs priority	★Legacy only, UEFI only

### 3.6 Save & Exit

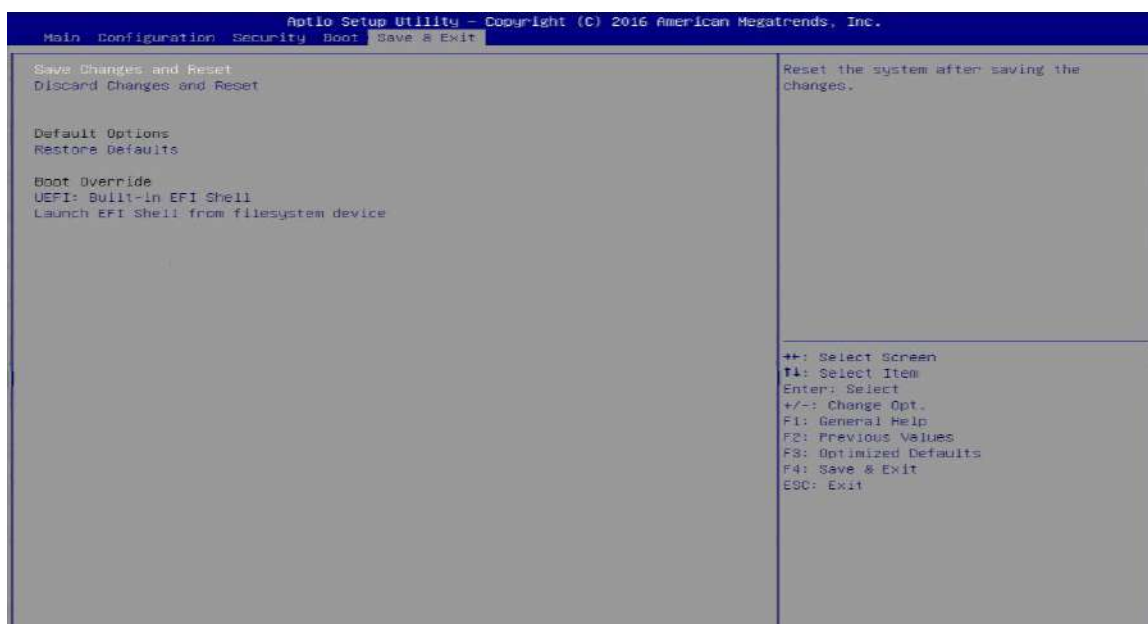

Feature	Description	Options
<b>Save Changes and Reset</b>	Equal to F10, save all changes of all menus, then exit setup configure driver. Finally resets the system automatically.	
<b>Discard Changes and Reset</b>	Equal to ESC, never save changes, then exit setup configure driver.	
<b>Restore Defaults</b>	Restore/Load Default values for all the setup options.	
<b>UEFI: Built-in EFI Shell (Boot option filter: UEFI only)</b>	Reset the system after saving the changes.	
<b>Launch EFI Shell from filesystem device</b>	Attempts to Launch EFI Shell application (Shell.efi) from one of the available filesystem devices.	

## Chapter 4

### Important Instructions

This chapter includes instructions which must be carefully followed when the fan-less embedded system is used.

#### 4.1 Note on the Warranty

Due to their limited service life, parts which, by their nature, are especially subject to wear are not included in the guarantee beyond the legal stipulations.

#### 4.2 Exclusion of Accident Liability Obligation

Portwell, Inc. shall be exempt from the statutory accident liability obligation if users fail to abide by the safety instructions.

#### 4.3 Liability Limitations / Exemption from the Warranty Obligation

In the event of damage to the system unit caused by failure to abide by the hints in this manual and on the unit (especially the safety instructions), Portwell, Inc. shall not be required to respect the warranty even during the warranty period and shall be free from the statutory accident liability obligation.

#### 4.4 Declaration of Conformity

##### EMC

CE/FCC Class A

This equipment complies with Part 15 of the FCC Rules. Operation is subject to the following two conditions:

1. This equipment may not cause harmful interference.
2. This equipment must accept any interference that may cause undesired operation.

##### Applicable Standards:

EN 55032: 2012 + A1: 2007, Class A

EN 61000-3-2: 2006

EN 61000-3-3: 1995 + A1: 2001 + A2: 2005

EN 55024: 1998 + A1: 2001 + A2: 2003

IEC 61000-4-2: 2008

IEC 61000-4-3: 2006 + A1: 2007

IEC 61000-4-4: 2004

IEC 61000-4-5: 2005

IEC 61000-4-6: 2007

IEC 61000-4-8: 1993 + A1: 2000

IEC 61000-4-11: 2004

FCC 47 CFR Part 15 Subpart FCC 47 CFR Part 15 Subpart

## Chapter 5

### Frequent Asked Questions

**Question: I forgot my password of system BIOS, what am I supposed to do?**

**Answer:**

You can switch off your power supply then find the JP5 on the WADE-8017 board to set it from 1-2 short to 2-3 short and wait 5 seconds to clean your password then set it back to 1-2 short to switch on your power supply.

JP5: CMOS Setting

	Jumper Setting Describe
*1-2	Default
2-3	Clean CMOS

**Question: How to update the BIOS file?**

**Answer:**

1. Please visit web site of [Portwell download center](http://www.portwell.com.tw/support/download_center.php) as below hyperlink  
[http://www.portwell.com.tw/support/download\\_center.php](http://www.portwell.com.tw/support/download_center.php)  
**Registering** an account in advance is a must. (The E-Mail box should be an existing Company email address that you check regularly.)  
<http://www.portwell.com.tw/member/newmember.php>
2. Type in your User name and password and log in the download center.
3. Select "Search download" and type the keyword "WADE-8017".
4. Find the "BIOS" page and download the ROM file and flash utility.
5. Unzip file to bootable USB flash drive which can boot to dos mode. Then execute the "update.bat" or "update.efi". It will start to update BIOS.

**NOTE:** Once you use "update.efi" to update BIOS, it must be get into the SHELL MODE to update BIOS



```
Microsoft(R) Windows 98
(C)Copyright Microsoft Corp 1981-1999.
C:\>update_
```

DOS MODE: update.bat

```

EFI Shell version 2.40 [5.11]
Current running mode 1.1.2
device mapping table
fs0 :Removable HardDisk - Alias hd6d0b0b blk0
      PciRoot(0x0)/Pci(0x14,0x0)/USB(0x3,0x0)/USB(0x1,0x0)/HD(1,MBR,0x044C0BFO
,0x3F,0x79B141)
blk0 :Removable HardDisk - Alias hd6d0b0b fs0
      PciRoot(0x0)/Pci(0x14,0x0)/USB(0x3,0x0)/USB(0x1,0x0)/HD(1,MBR,0x044C0BFO
,0x3F,0x79B141)
blk1 :Removable BlockDevice - Alias (null)
      PciRoot(0x0)/Pci(0x14,0x0)/USB(0x1,0x0)/USB(0x0,0x0)
blk2 :Removable BlockDevice - Alias (null)
      PciRoot(0x0)/Pci(0x14,0x0)/USB(0x3,0x0)/USB(0x1,0x0)

Press ESC in 1 seconds to skip startup.nsh, any other key to continue.
Shell> fs0:
fs0:\> cd update
fs0:\Update> update_
    
```

SHELL MODE: SHELL MODE

6. When you see the “FPT Operation Passed” message, which means the BIOS update processes finished. Please cut the AC power off and **wait for 10 seconds** before powering on.

```

- Erasing Flash Block [0x0E3000] - 100% complete.
- Programming Flash [0x0E3000] 4KB of 4KB - 100% complete.
- Erasing Flash Block [0x007000] - 100% complete.
- Programming Flash [0x007000] 28KB of 28KB - 100% complete.
- Erasing Flash Block [0x026000] - 100% complete.
- Programming Flash [0x026000] 28KB of 28KB - 100% complete.
- Erasing Flash Block [0x040000] - 100% complete.
- Programming Flash [0x040000] 4KB of 4KB - 100% complete.
- Erasing Flash Block [0xC5E000] - 100% complete.
- Programming Flash [0xC5E000] 1940KB of 1940KB - 100% complete.
- Erasing Flash Block [0xFB7000] - 100% complete.
- Programming Flash [0xFB7000] 88KB of 88KB - 100% complete.
- Erasing Flash Block [0xFD9000] - 100% complete.
- Programming Flash [0xFD9000] 4KB of 4KB - 100% complete.
- Verifying Flash [0x100000] 16384KB of 16384KB - 100% complete.
RESULT: The data is identical.
FPT Operation Passed
C:\_FLASH>
C:\>
    
```

DOS MODE: update.bat

```

AFTER UPDATING COMPLETE!
64 Bit

Intel (R) Flash Programming Tool, Version: 2.0.0.2077
Copyright (C) 2007 - 2015, Intel Corporation. All rights reserved.

Platform: Cherry Trail
SpiloadDevicesFile(fparts.txt)...
Reading HSFSTS register... Flash Descriptor: Valid

--- Flash Devices Found ---
MX25U6495F ID:0xC22537 Size: 8192KB (65536Kb)

PDR Region does not exist.

- Erasing Flash Block [0x800000] - 100% complete.
- Programming Flash [0x800000] 8192KB of 8192KB - 100% complete.
- Verifying Flash [0x800000] 8192KB of 8192KB - 100% complete.
RESULT: The data is identical.
FPT Operation Passed
fs0:\Update> _
    
```

SHELL MODE: SHELL MODE

7. Press “del” key into the BIOS setup menu and switch to “Save & Exit” page then select “Restore Defaults” option and press “Yes” then select “Save Changes and Reset” to finish all BIOS update processes.



